



VAMISOUND

THE SOUND
IS YOURS

V47F

BUILDING
INSTRUCTIONS



VAMISOUND V47F BUILDING INSTRUCTIONS

WE SOUND BETTER

Dear **DIY** friend,

first of all thank you for your support and choice of the VAMISOUND product.
We wish you a happy DIY and the joy of a new microphone in your arsenal!!

Jan and Milan





VAMISOUND V47F BUILDING INSTRUCTIONS

WE SOUND BETTER

Before you start building your new microphone please carefully read this building instructions.

Attention: VAMISOUND V47F is a medium-heavy project. It should be borne in mind that certain manual skills will be required or the successful completion of the mic construction. Good soldering experience and soldering stations with fine soldering tip are recommended. If you do not have this, please delegate the construction to a more experienced technician with proper equipment. We are not responsible for malfunctioning construction or injuries associated with improper assembly of our kits.

Document info	
Document name	V47F building instructions
Document revision	1.3
PCB revision	1.0
Date	April 2026
Project difficulty	★ ★ ★ ★ ★
Complexity of soldering	★ ★ ★ ★ ★
Risk of electric shock	★ ★ ★ ★ ★
Changes and notes	16.02.2024 - fixed number of teflon pins in BOM (two) 08.09.2024 - R22 and R23 added, XLR insert info, two teflon pins info added 13.04.2026 - information about the second body type has been added

V47F printed circuit board set consists of four printed circuit boards – transformer pcb, main component pcb, HiZ section pcb and switch pcb. The set also includes two switches for PAD and HPF, two teflon pins, three polystyrene capacitors for HiZ section and also the interconnection hardware.

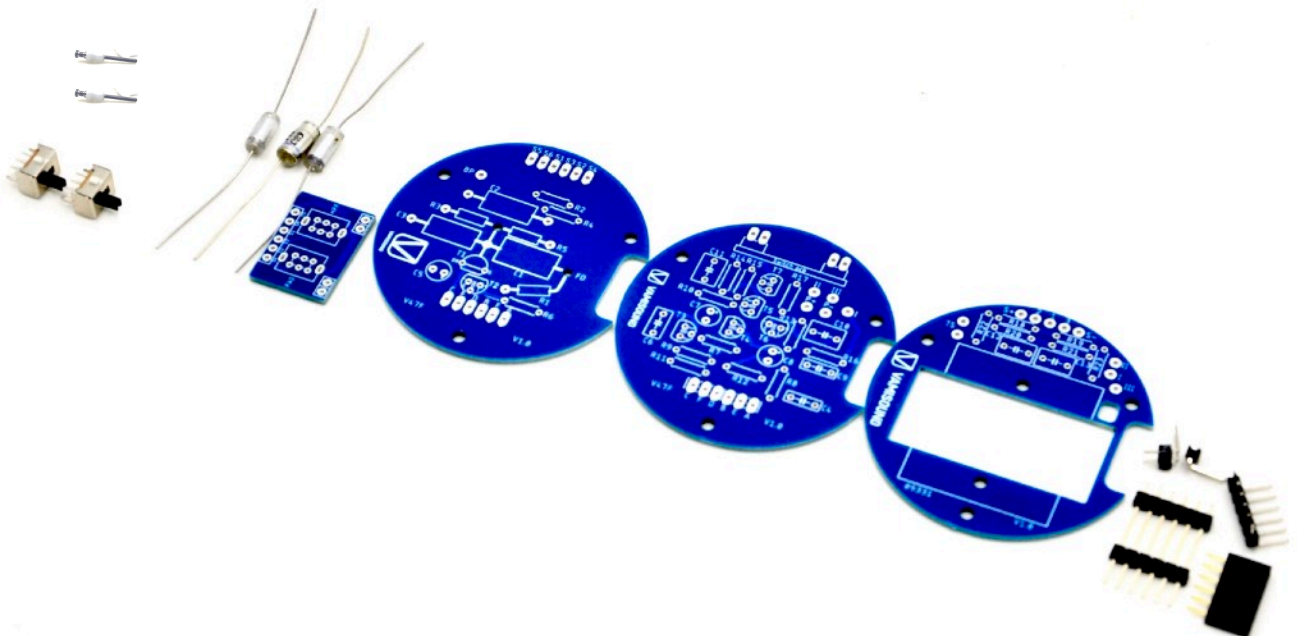
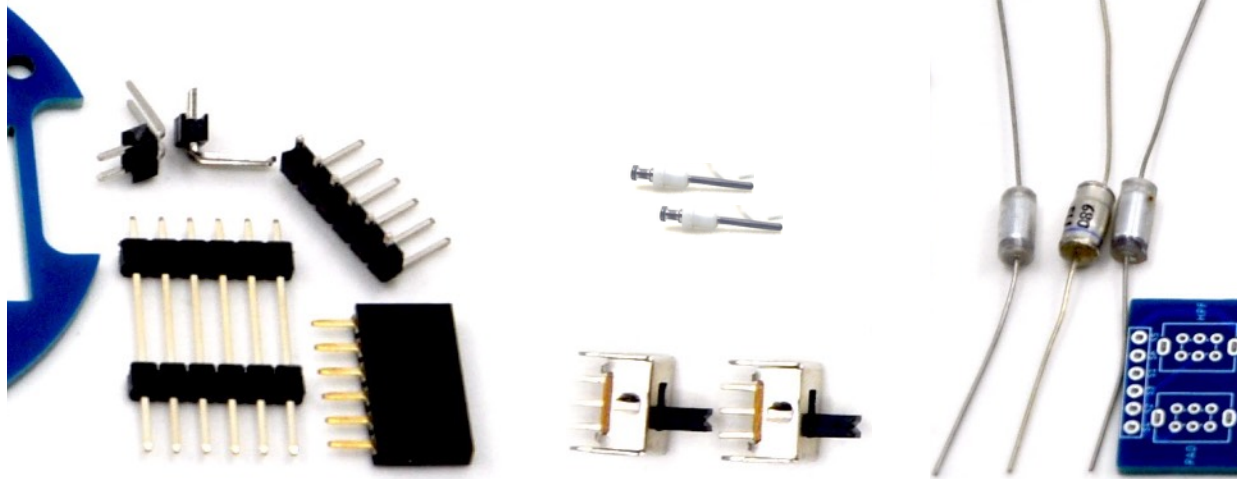
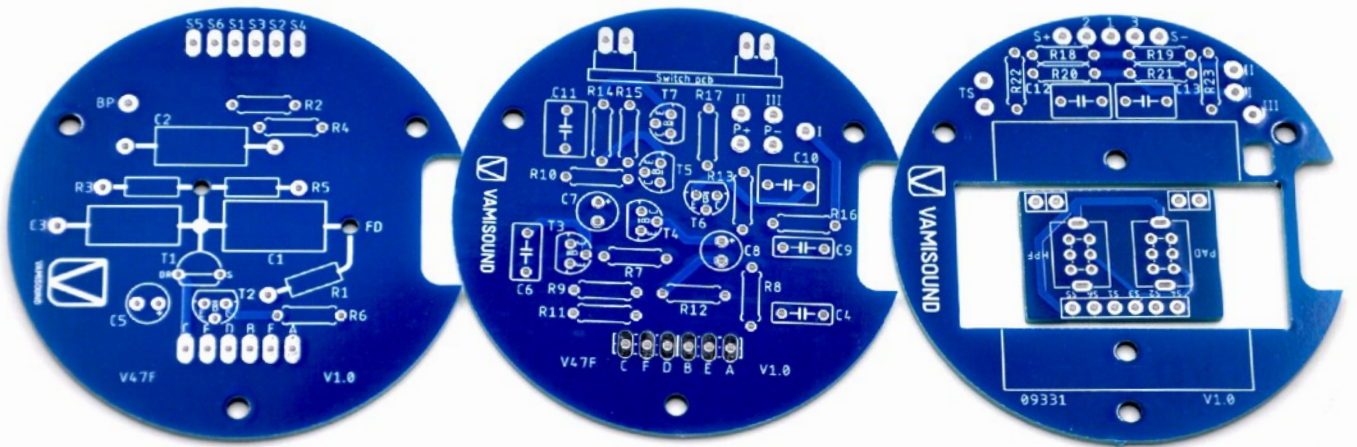

The soldering machine is hot so we can get started. We're gonna start by installing the transformer pcb. There are two matched resistor pairs. Specifically, R18 and R19 and the second matched pair R20 and R21. Match these pairs as close as possible. Solder also R22 and R23 (56R) resistors.

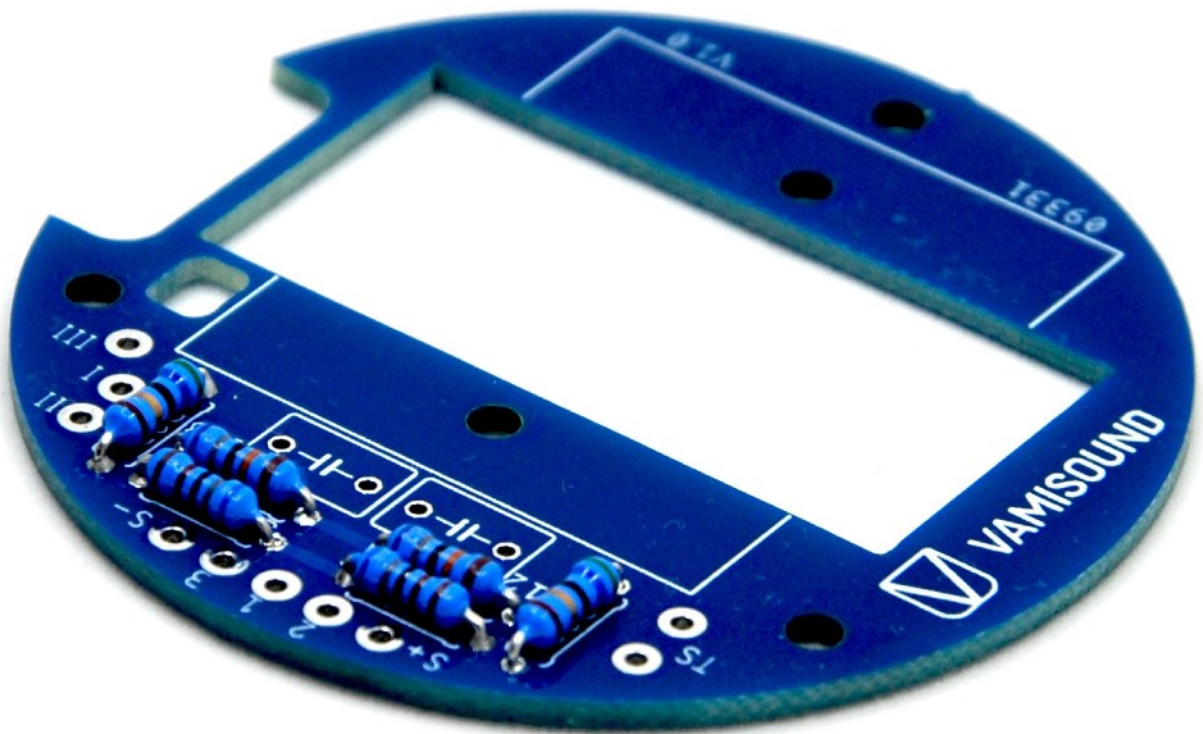

Next you proceed with two film Wima capacitors.

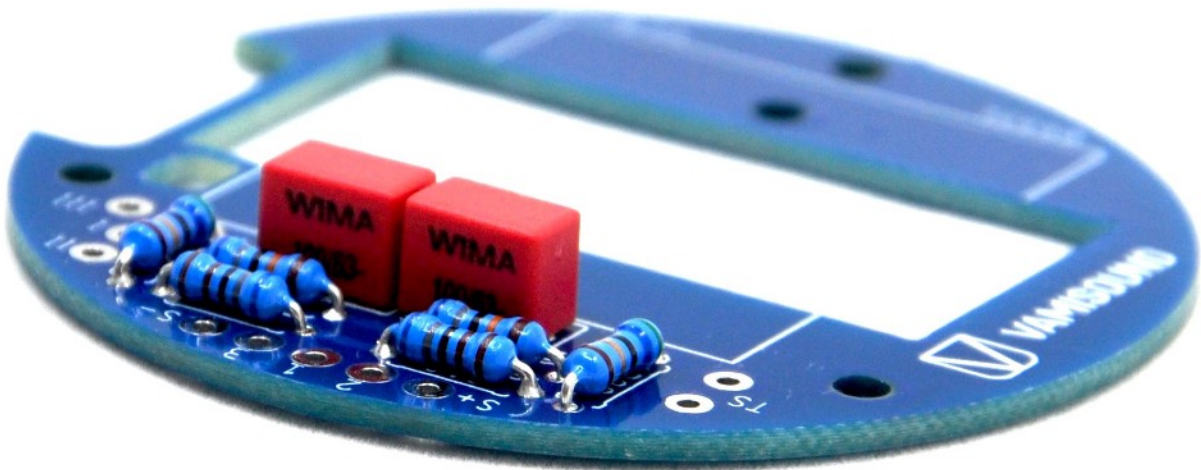

The transformer board is now fitted with all the components that need to be soldered. Let's move on.

Set the main parts board with all resistors.

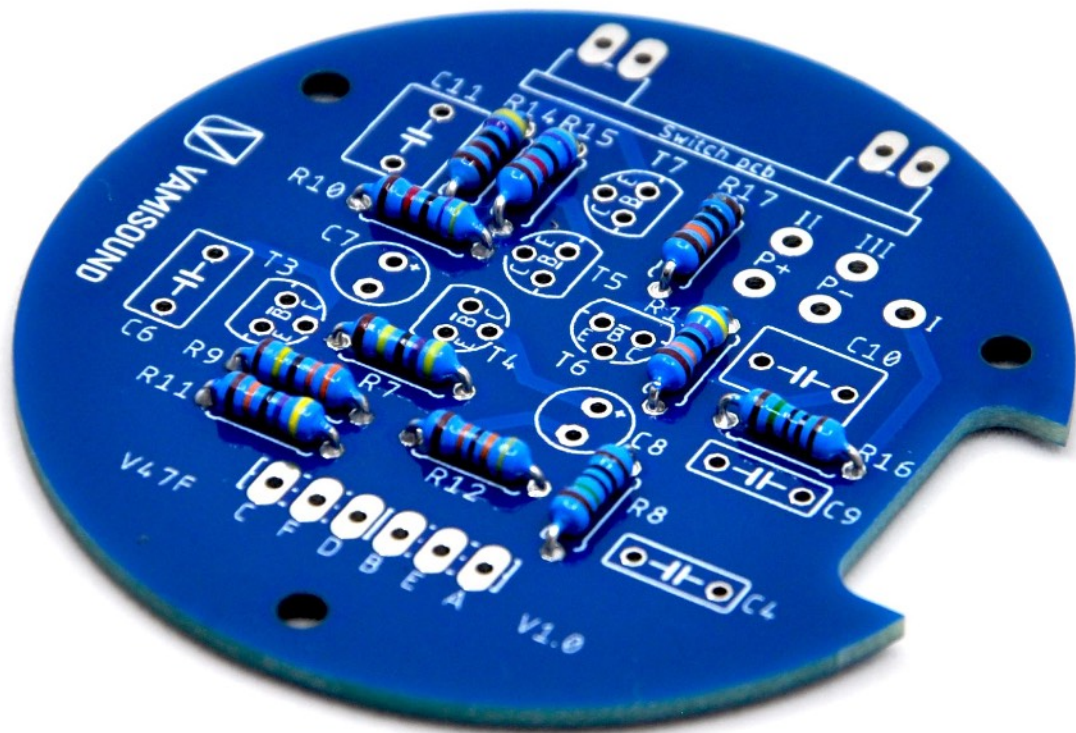

Proceed further with film capacitors.

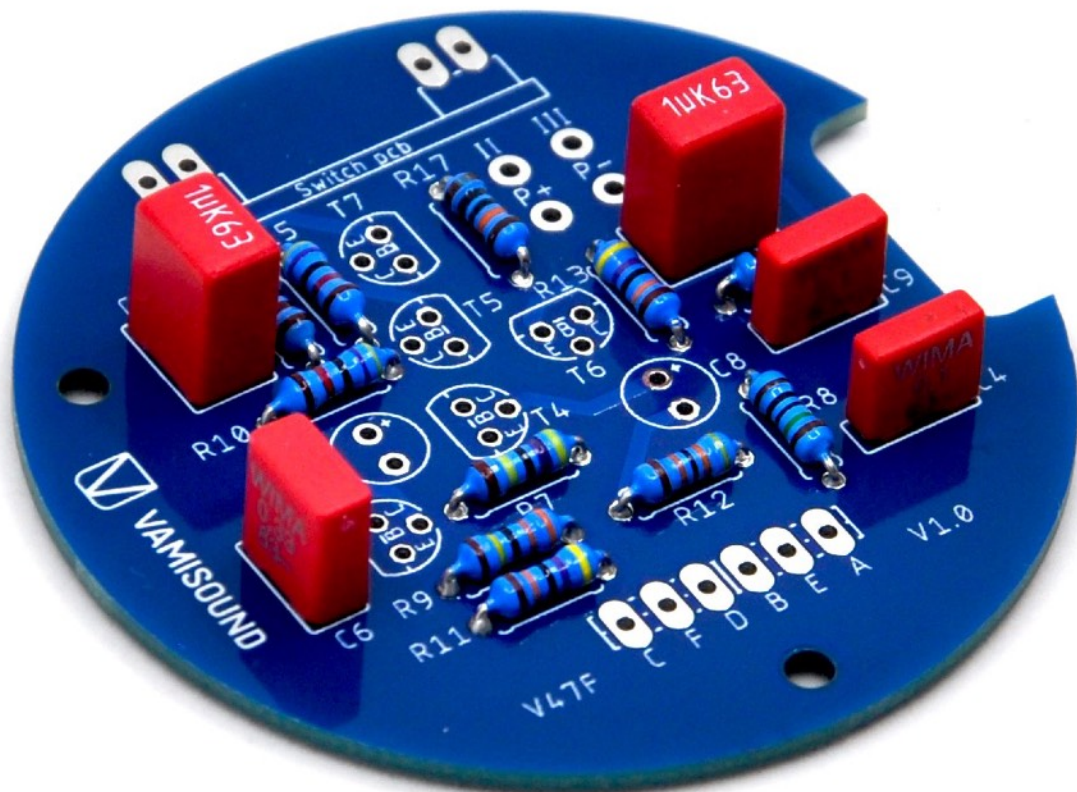

Solder four BC547B transistors to the board. Make sure to solder them in the correct direction as the footprint on the board.

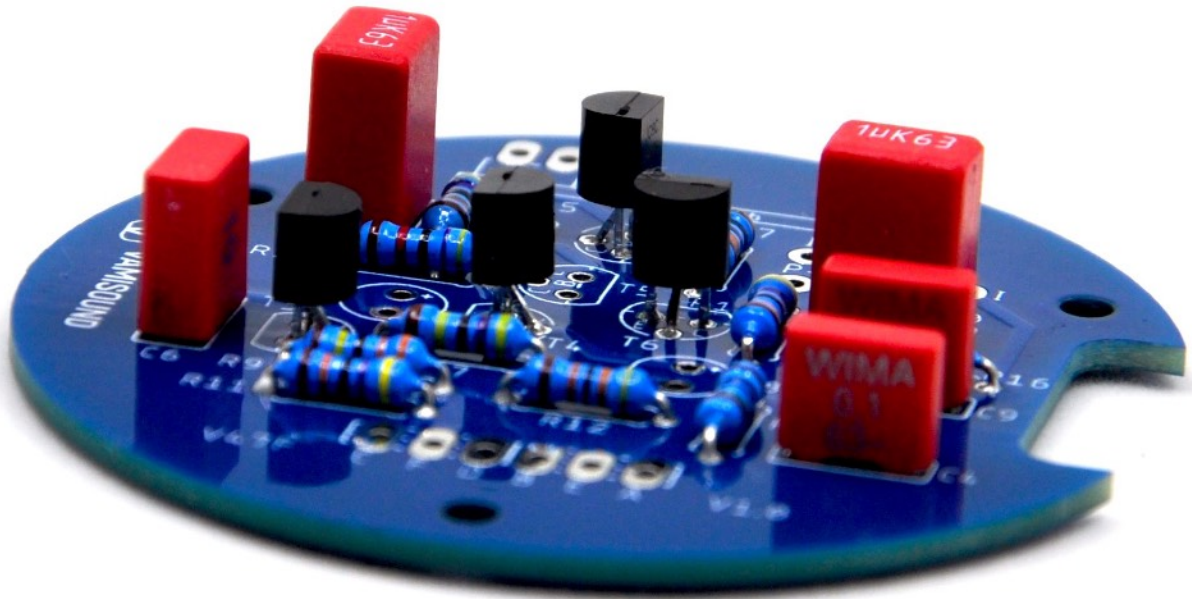

Continue by fitting one BC557B transistor in T5 position.

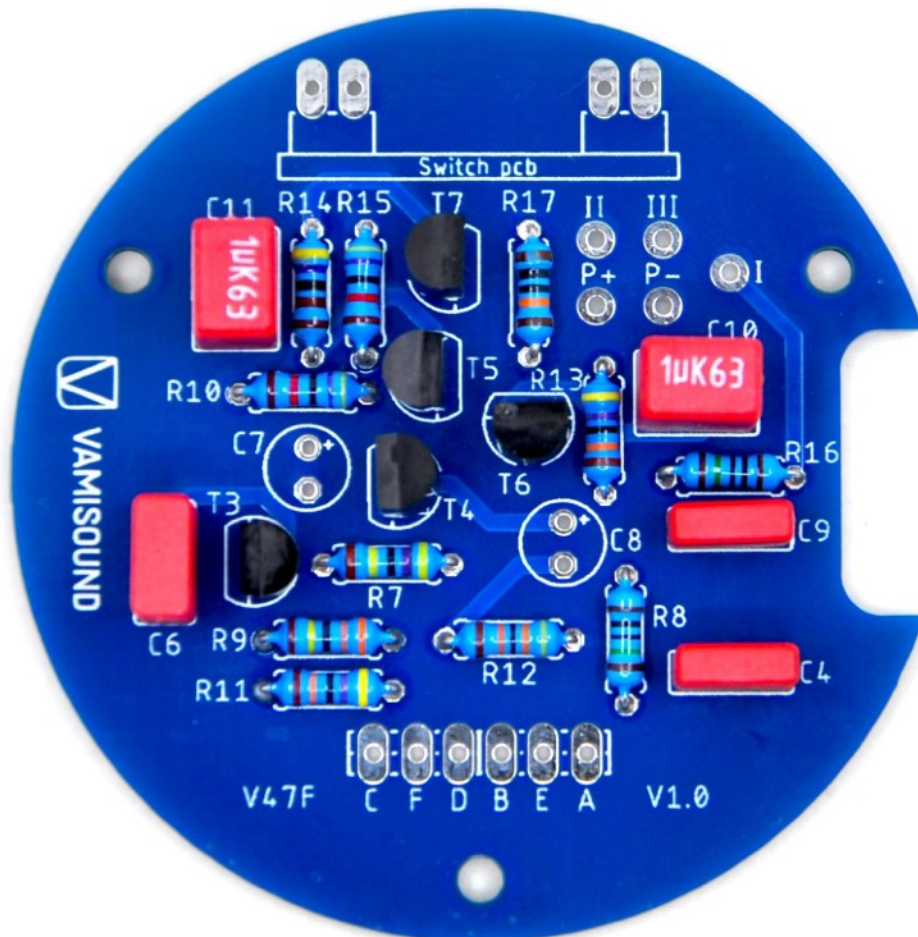

Now solder the switches to the switch board. Make sure they fit nicely in the board.

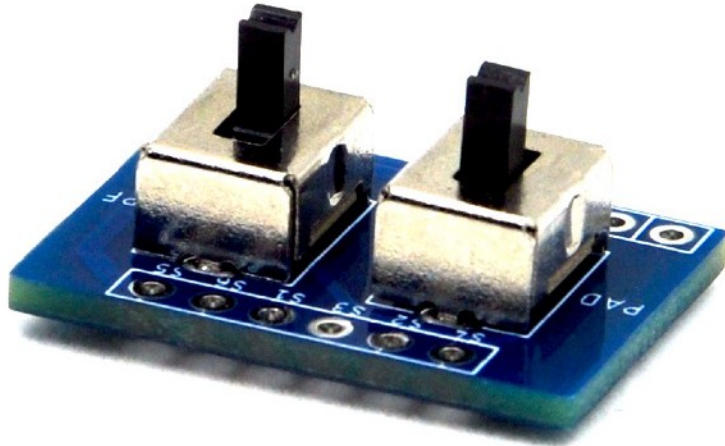

Also solder the pins.

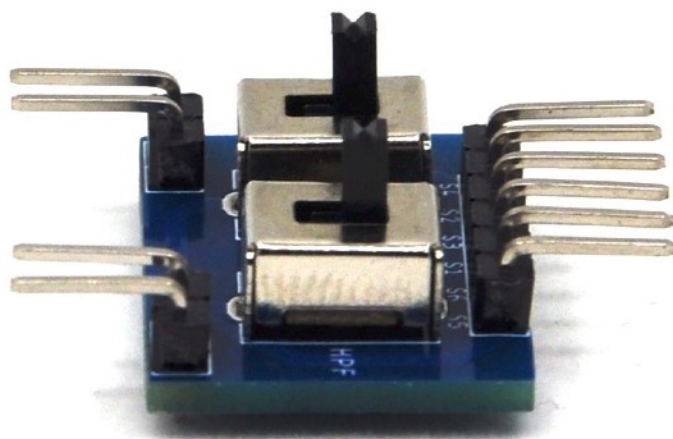

Clean the plates carefully with isopropyl alcohol. Take great care not to allow liquid to enter the switches.

Clamp the protruding part of the pins from the underside with pliers.

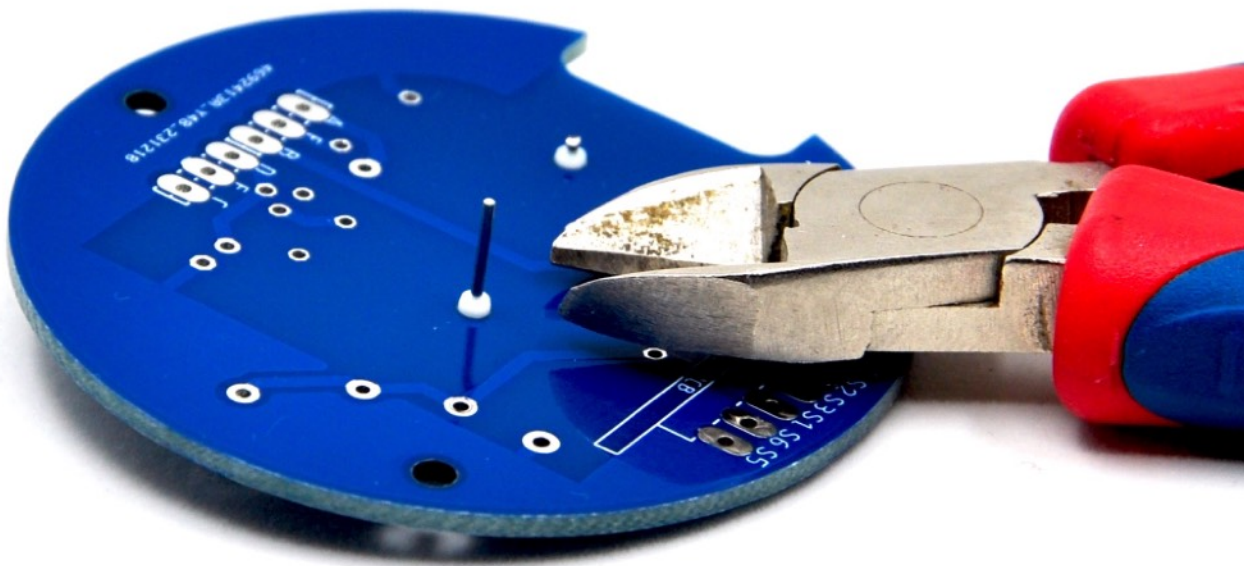

On the HiZ board we start first with the point to point section. You install the FET and lead its GATE pin through the air to the teflon pin.

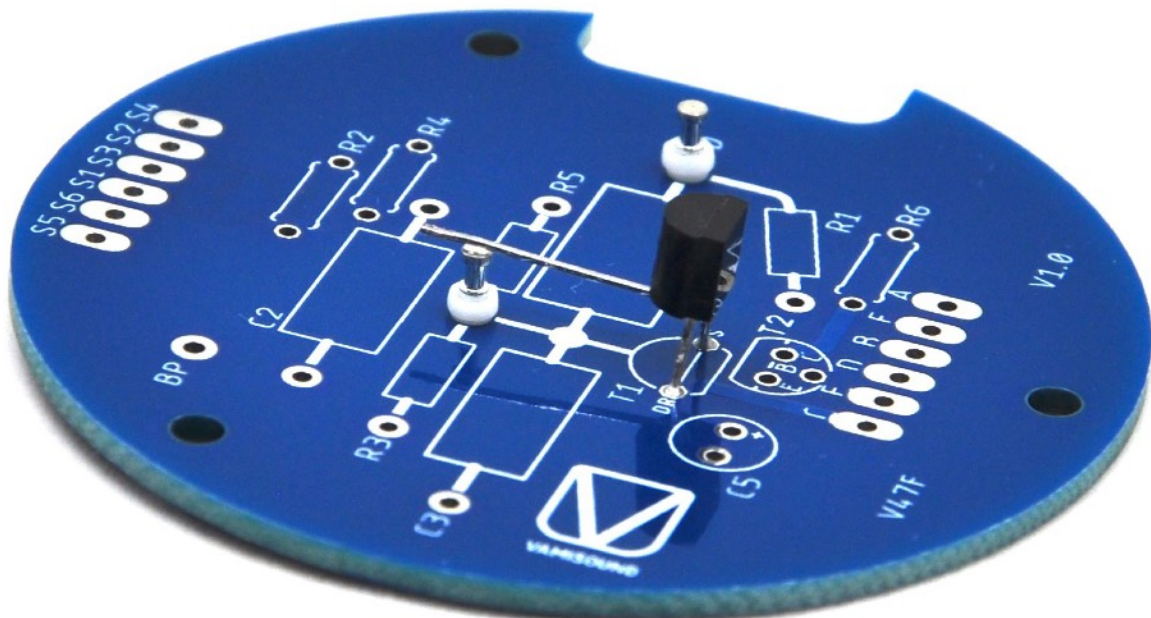
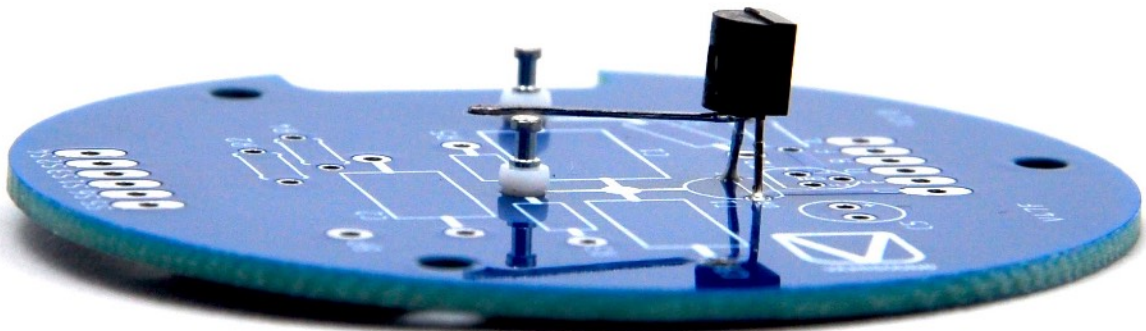

Continue with resistor R5 and R3. Put one of its legs on the teflon pin.

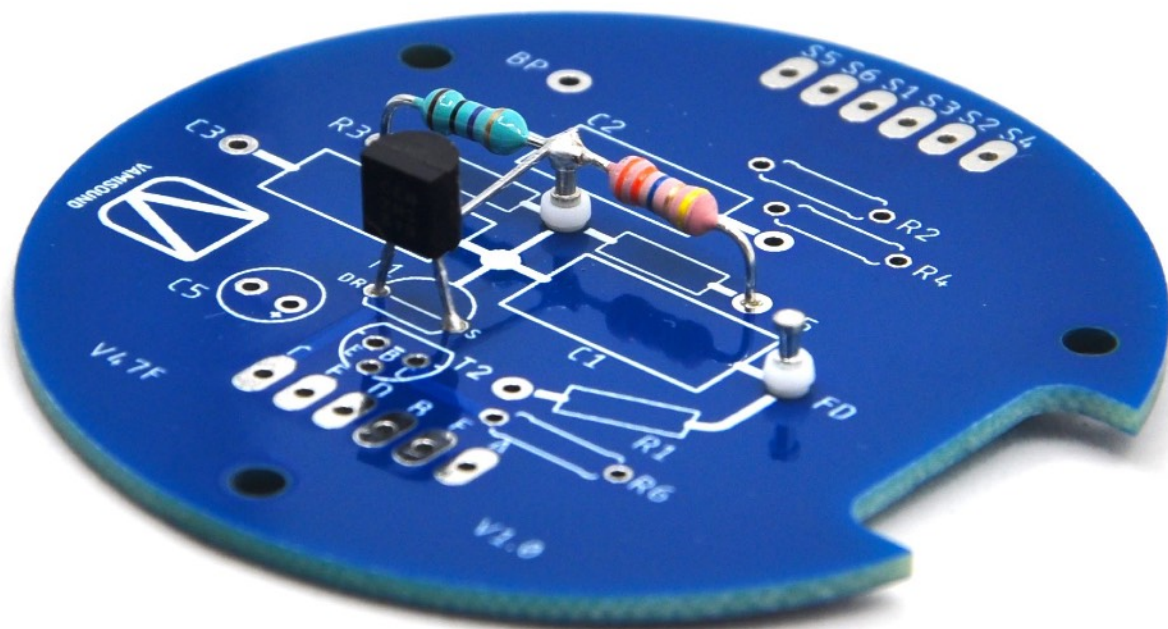
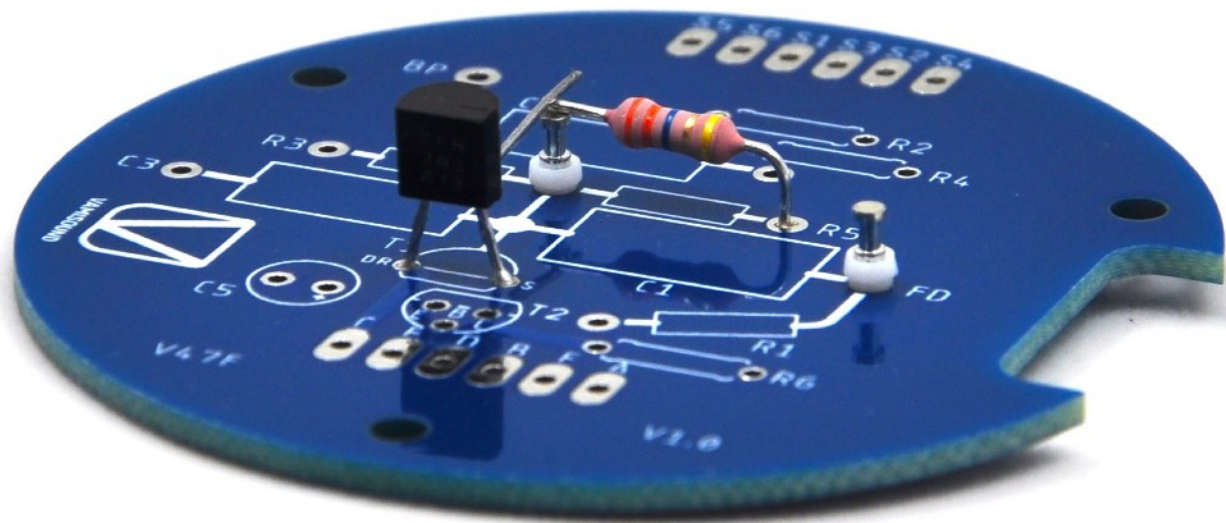

Solder R1. Its one leg is also on a teflon pin. Solder R4 and R6 as well.

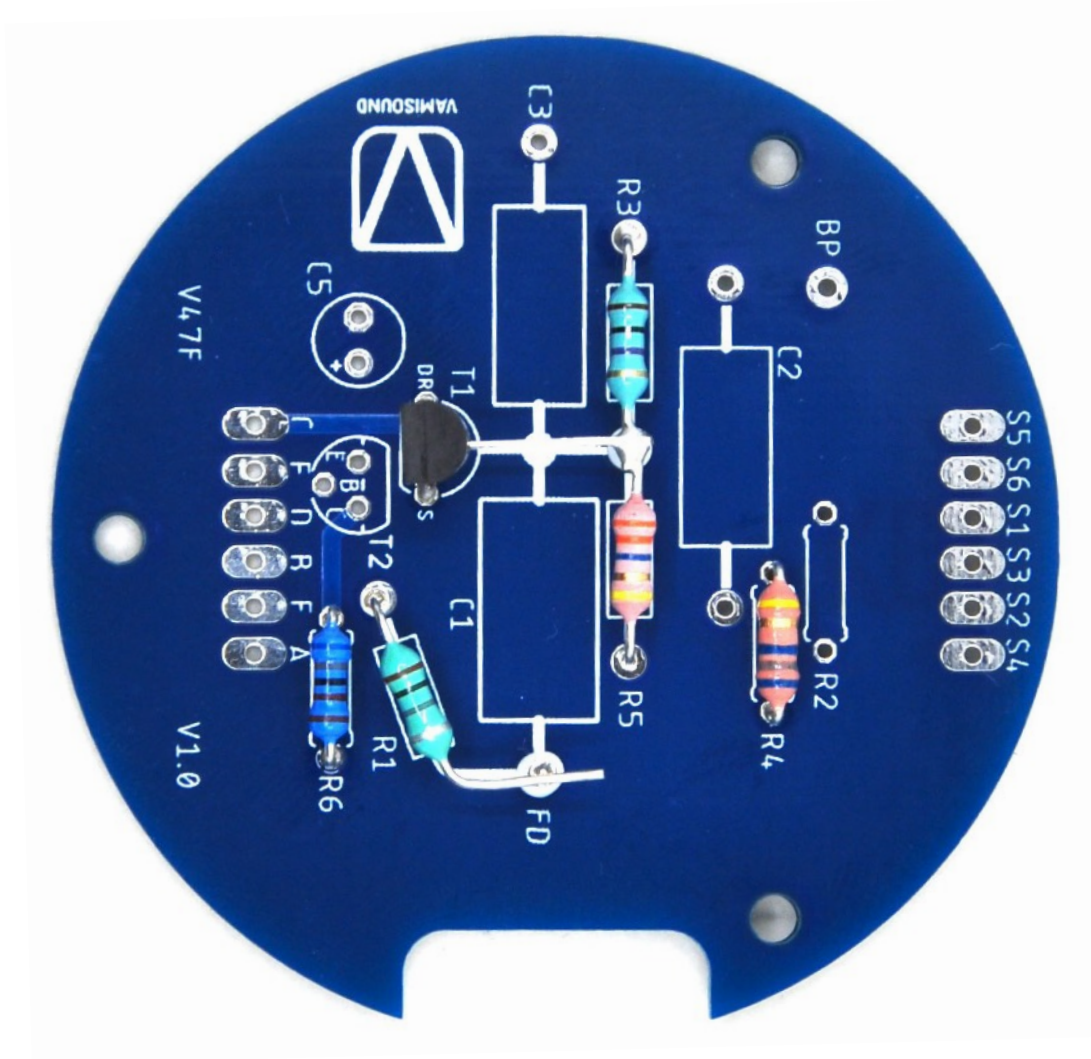

R2 is a 220M resistor. This value is very hard to find. So we use a series combination of two resistors 100M and 120M to give us the desired value in the result. Connect the legs at the top of the two resistors and solder them together. Make sure this resistor point is not too high. No higher than 10mm.

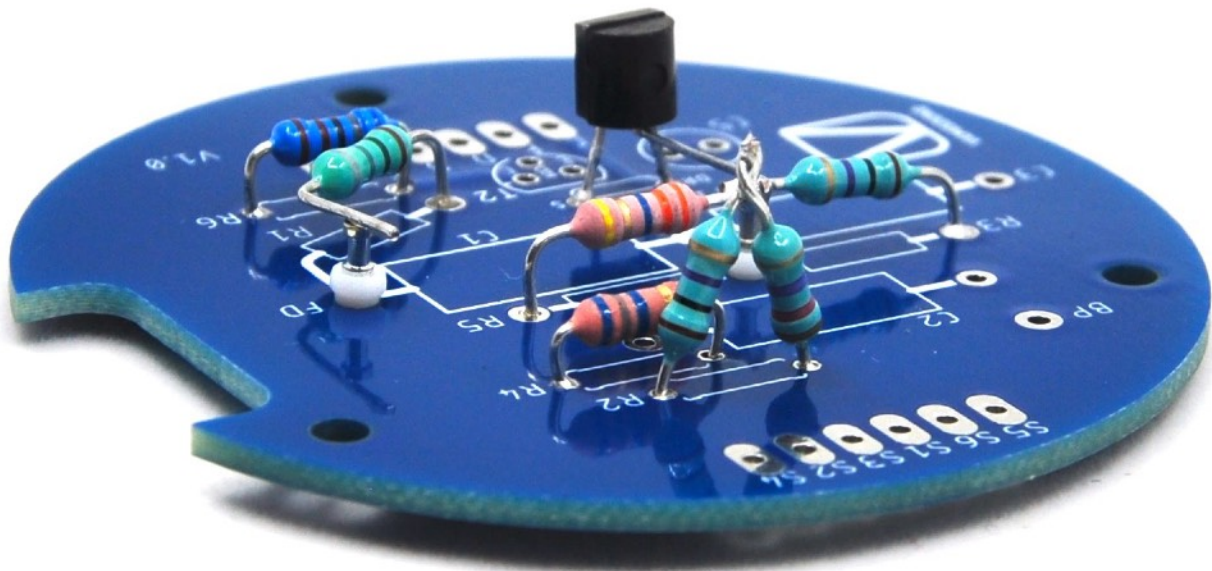

Now solder the BC557B transistor. Be cautious of its correct orientation.



And also an electrolytic capacitor. Orientation matters here again. The longer foot goes into the + pad on his footprint.

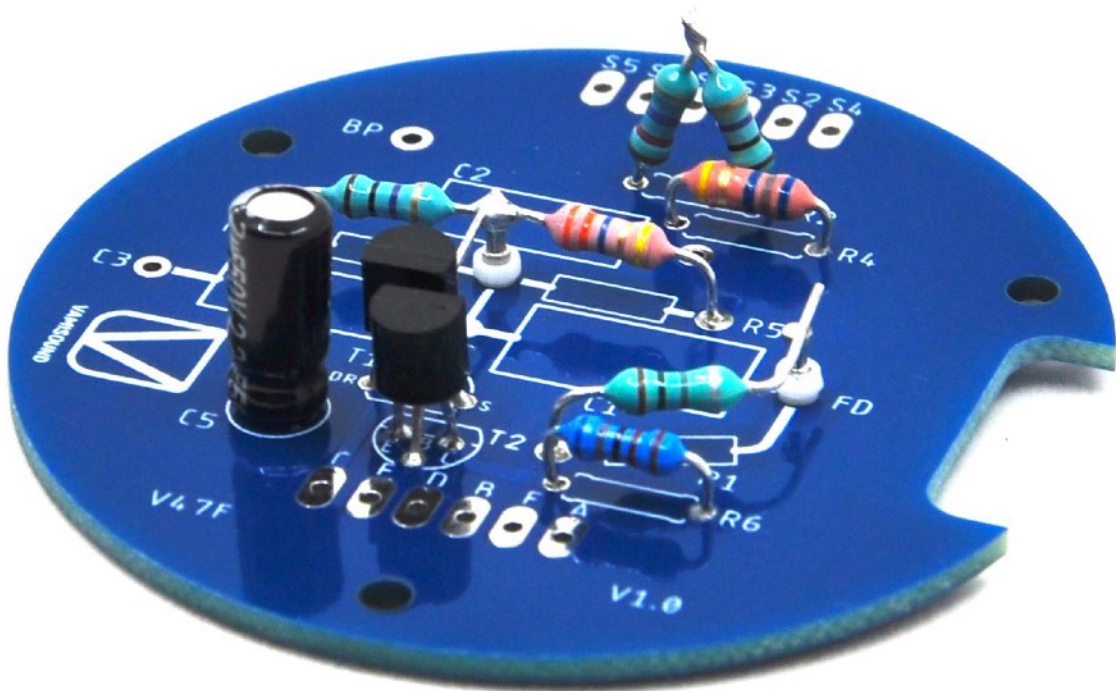

Clean the entire HiZ pcb with isopropyl alcohol.

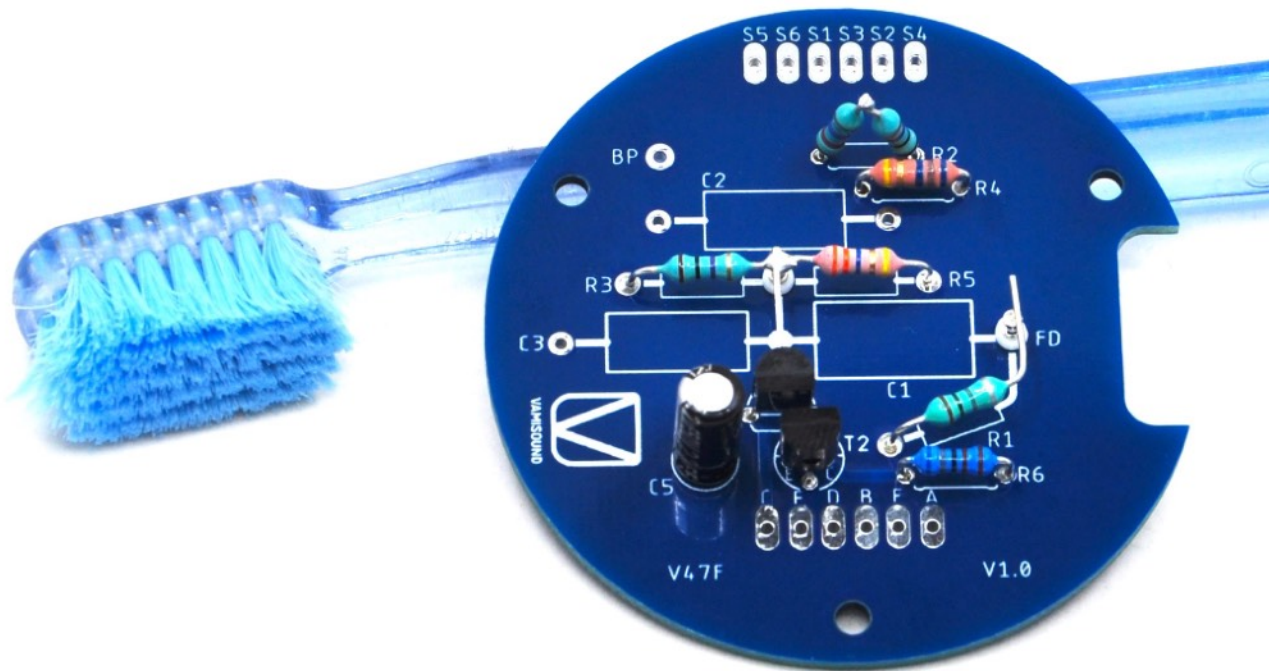

Now carefully solder the polystyrene capacitors. Be careful as these are very sensitive to over-soldering.

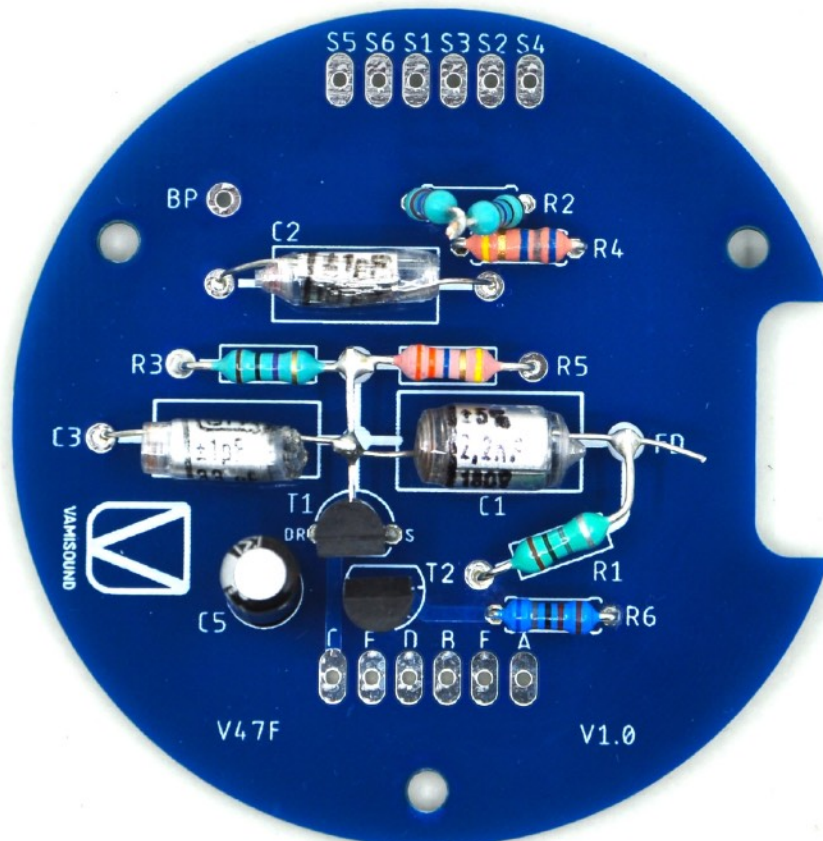

Now it's time to install the output transformer. Always use the transformer manual for proper wiring.

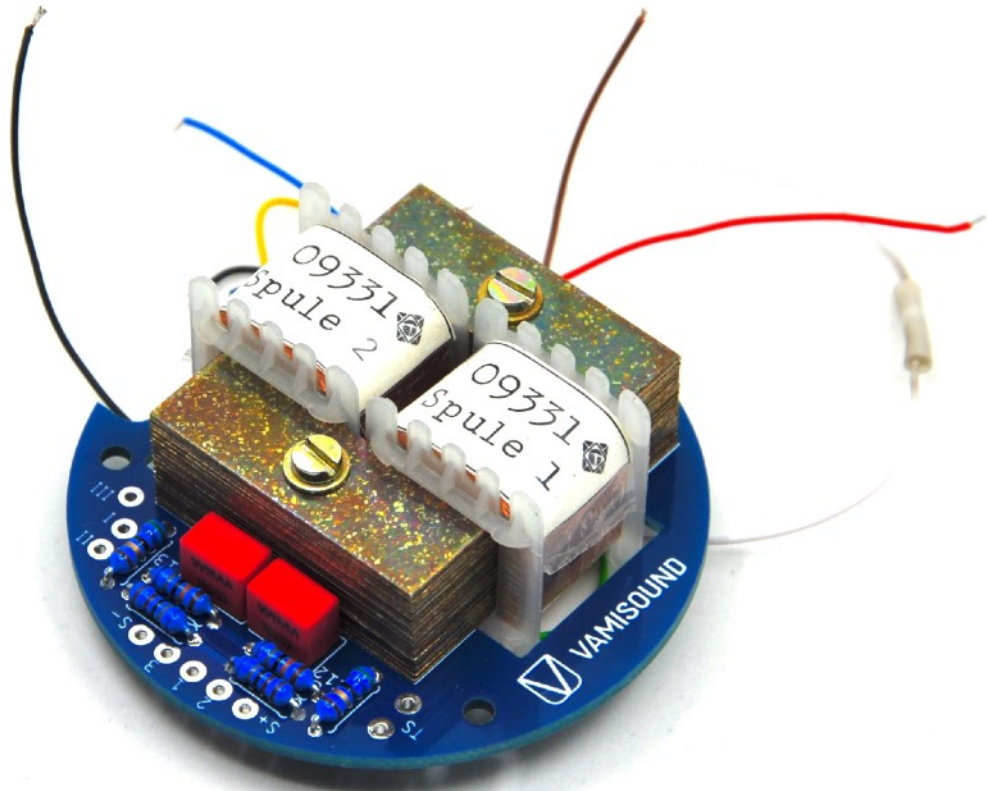

According to transformer manual, you need to connect the yellow and green wires on the transformer and also connect the two white wires. Insulate these connections with shrink wrap.

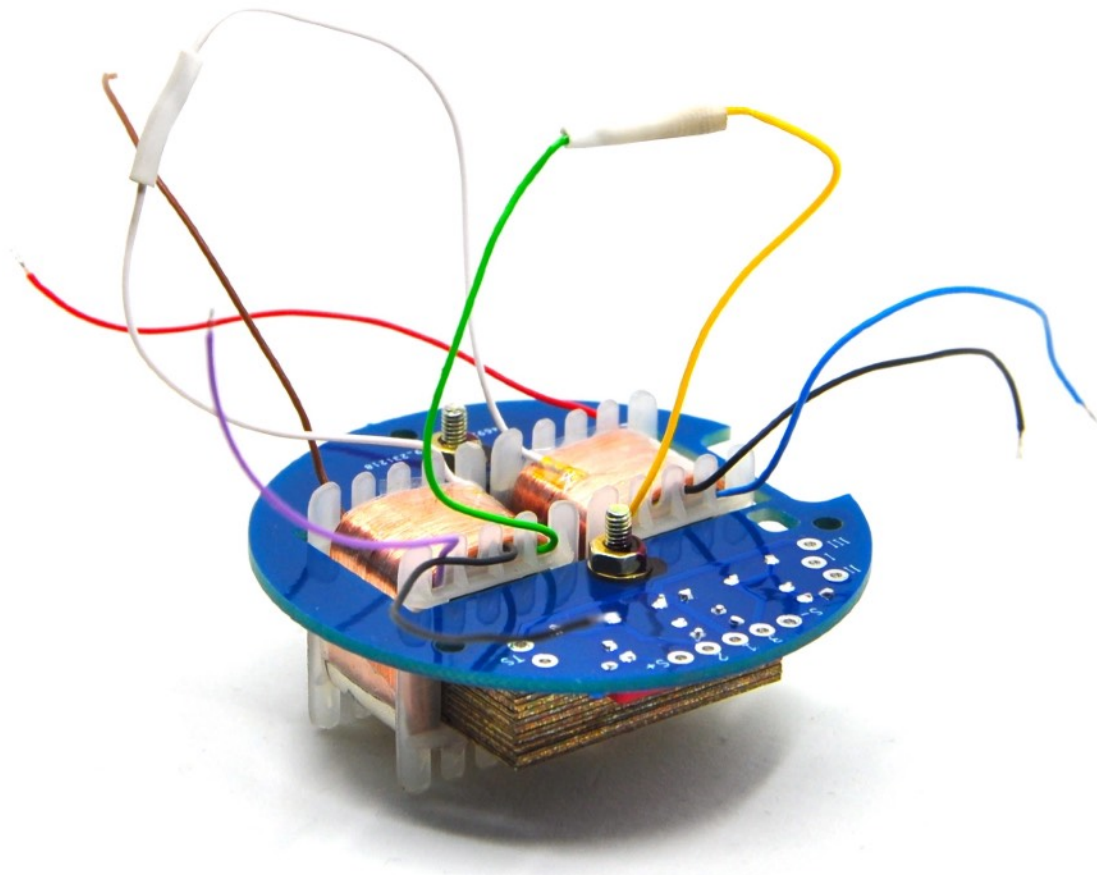

The two black transformer wires are the shield. Solder them to the pads on the transformer pcb, which are marked "TS" (=transformer shield). Connect the purple wire to the "S-" pad on the transformer circuit board. Blue wire to pad "S+". Push the brown and red wires through the hole in the board, as it were, upwards.

In the event that you would have missed the wire, extend it. In my case I had to extend the brown wire from the transformer to reach the main parts pcb later.

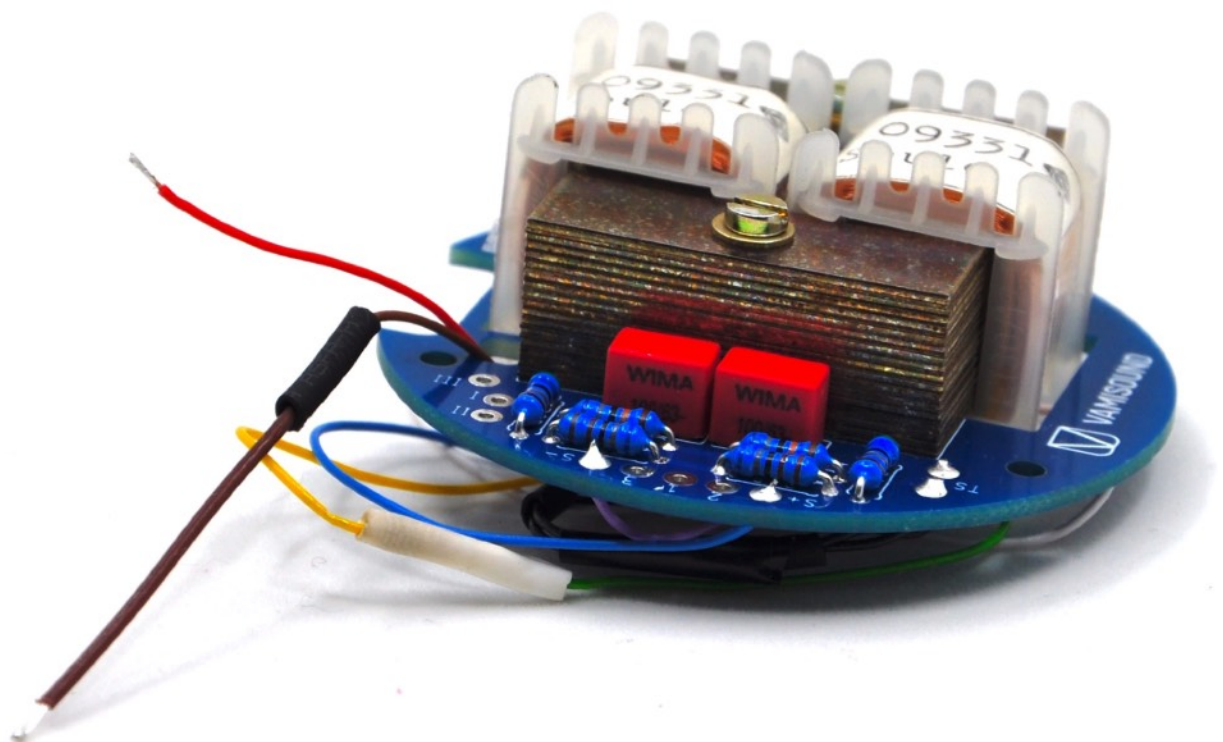
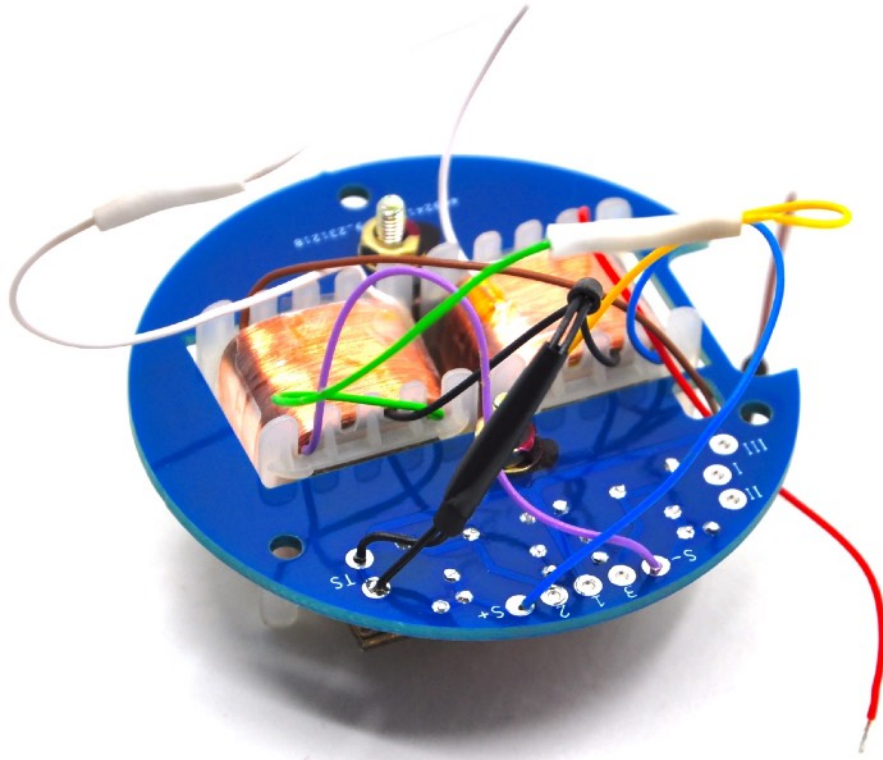

Install three 20mm long M2.5 spacers on the transformer board. Also prepare three wires approximately 80mm long.

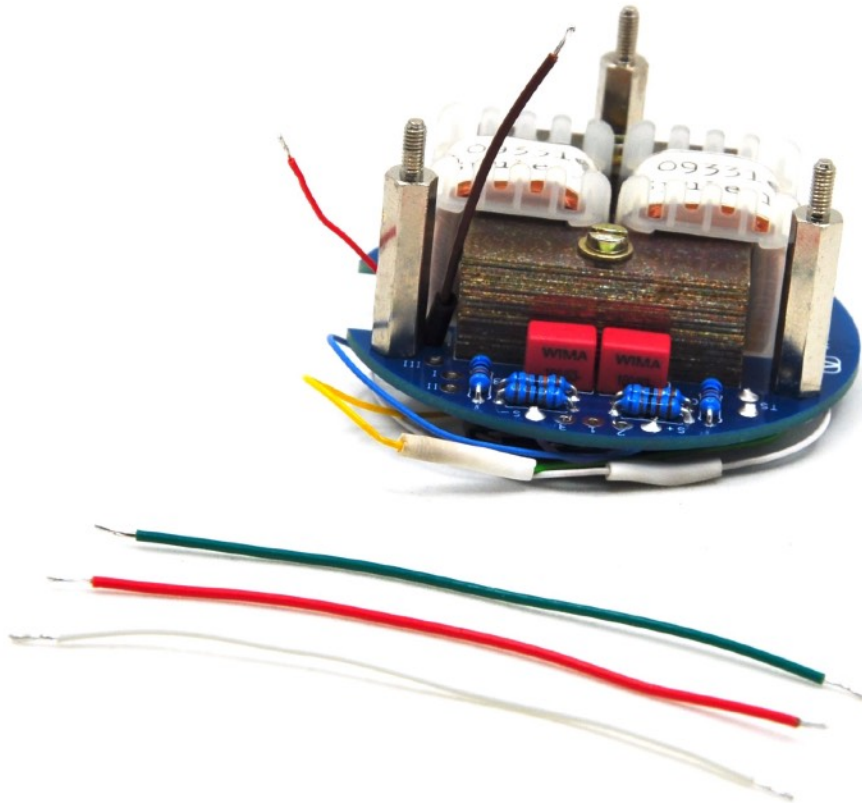

Solder the three wires to pads I, II and III on the transformer board and thread it up through the hole.

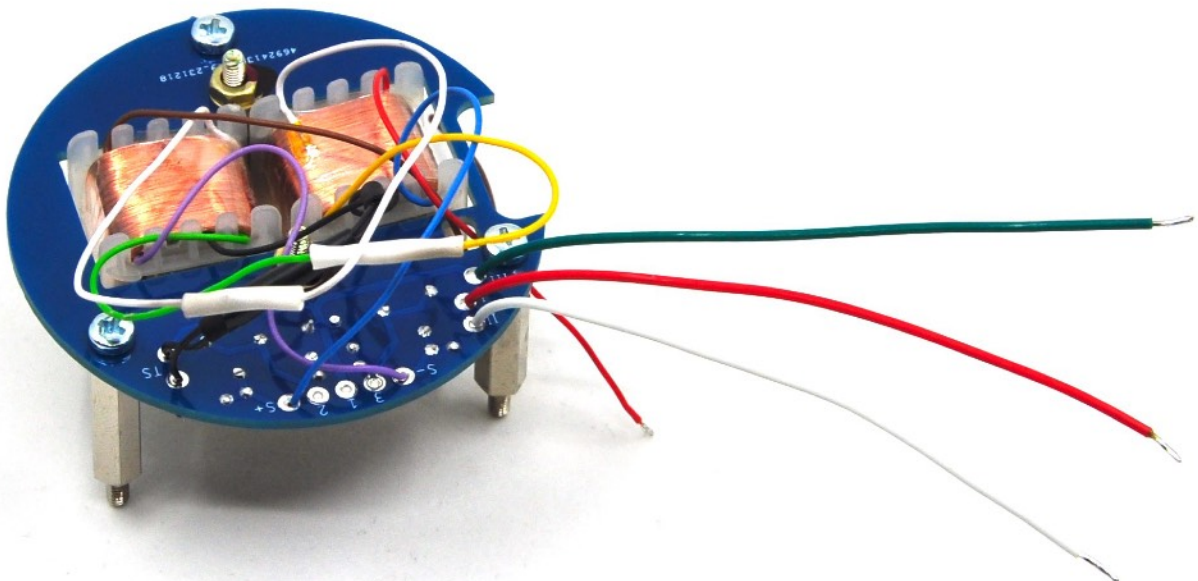

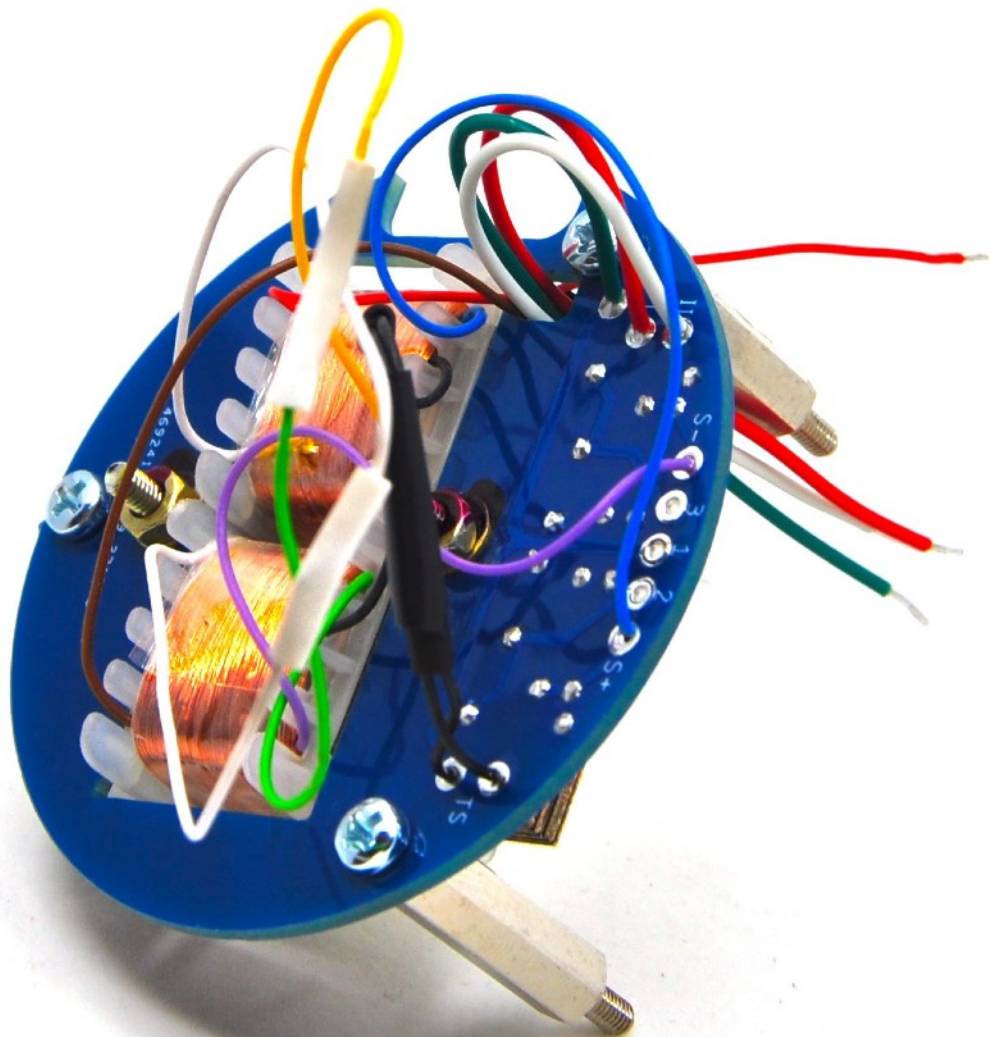
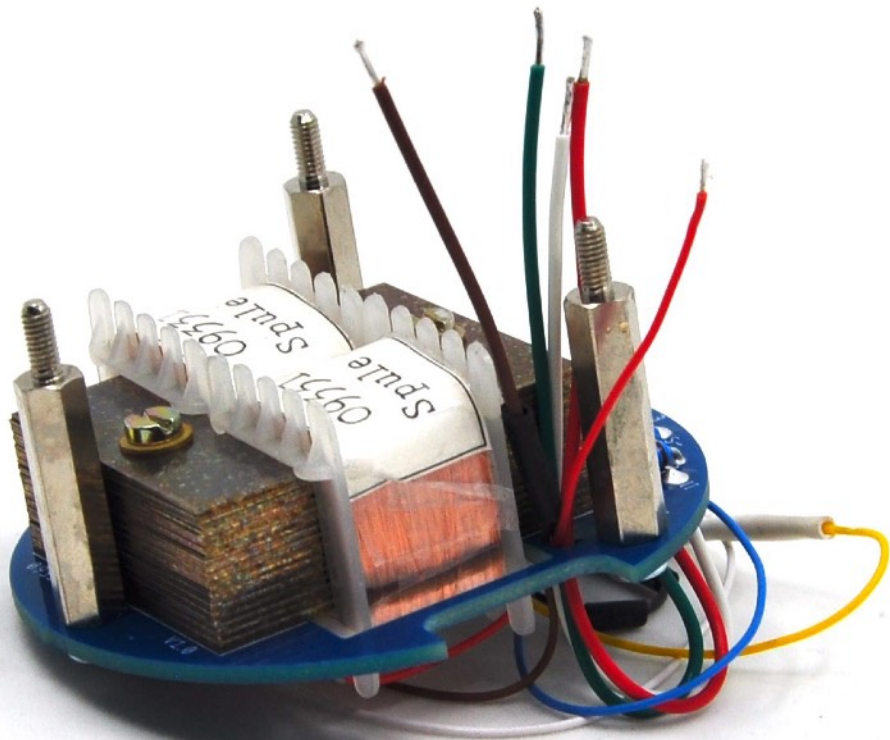

Now solder the three mentioned wires to pads named as I, II and III this time to the main parts pcb. You also connect the red cable from the transformer to the "P+" pad and the brown cable from the transformer to the "S-" pad on the main parts pcb.

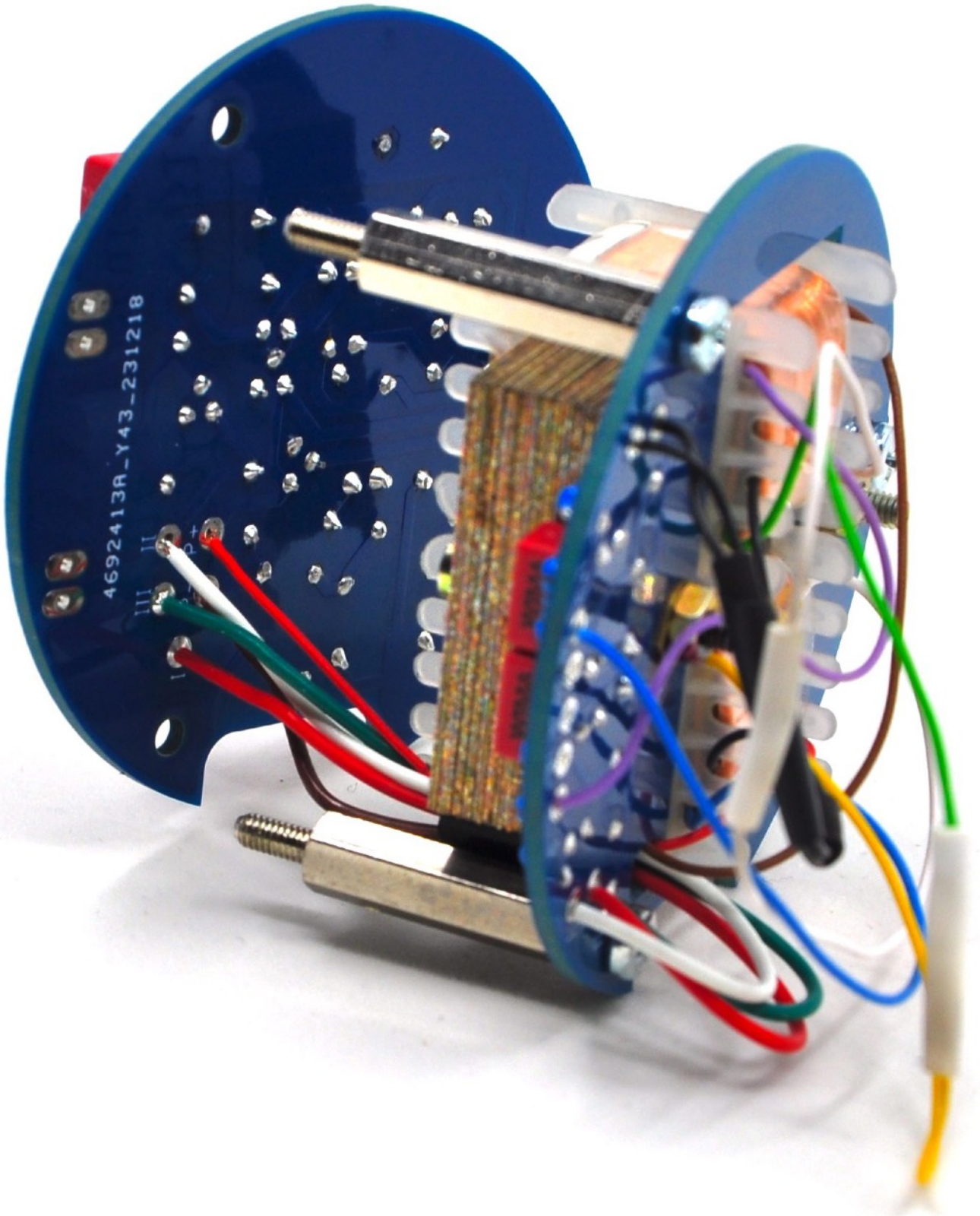

Now prepare the XLR insert. Solder 3 wires to it and also connect via remaining resistor leg pin 1 to the ground lug on XLR insert as you can see in the picture.



Connect the so prepared connector insert to the transformer pcb, to the pads marked 1, 2 and 3. XLR1 to pad 1, XLR2 to pad 2 and XLR3 to pad 3. Also note that three M2.5 spacers of 17mm length have been installed on the main parts pcb. These two interconnected boards are now holding together nicely.

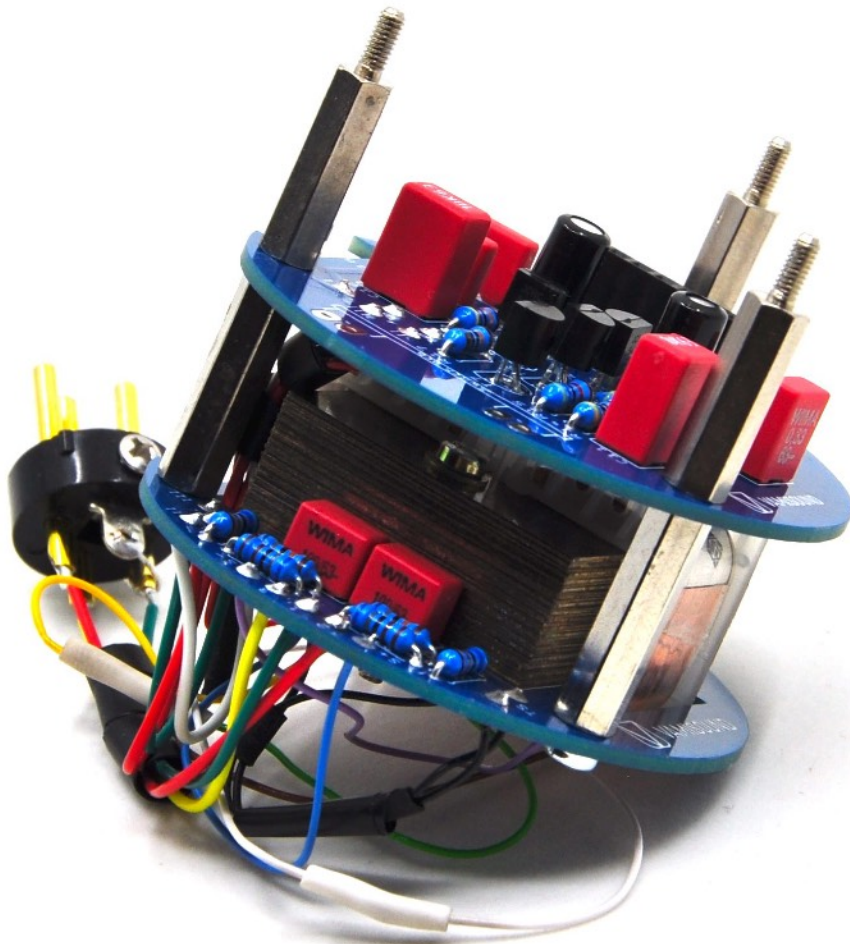

Take the six pin male connector and short its pins as you see in the picture. Use pliers.



Install the prepared switch pcb into the four holes on the main parts pcb. Do not solder anything. Also tuck that shortened six pin connector into its counterpart (black female connector on main parts pcb). Make sure that this connector is all the way in and fits nicely in the female connector. Move the black plastic pin holder on this male connector if necessary.

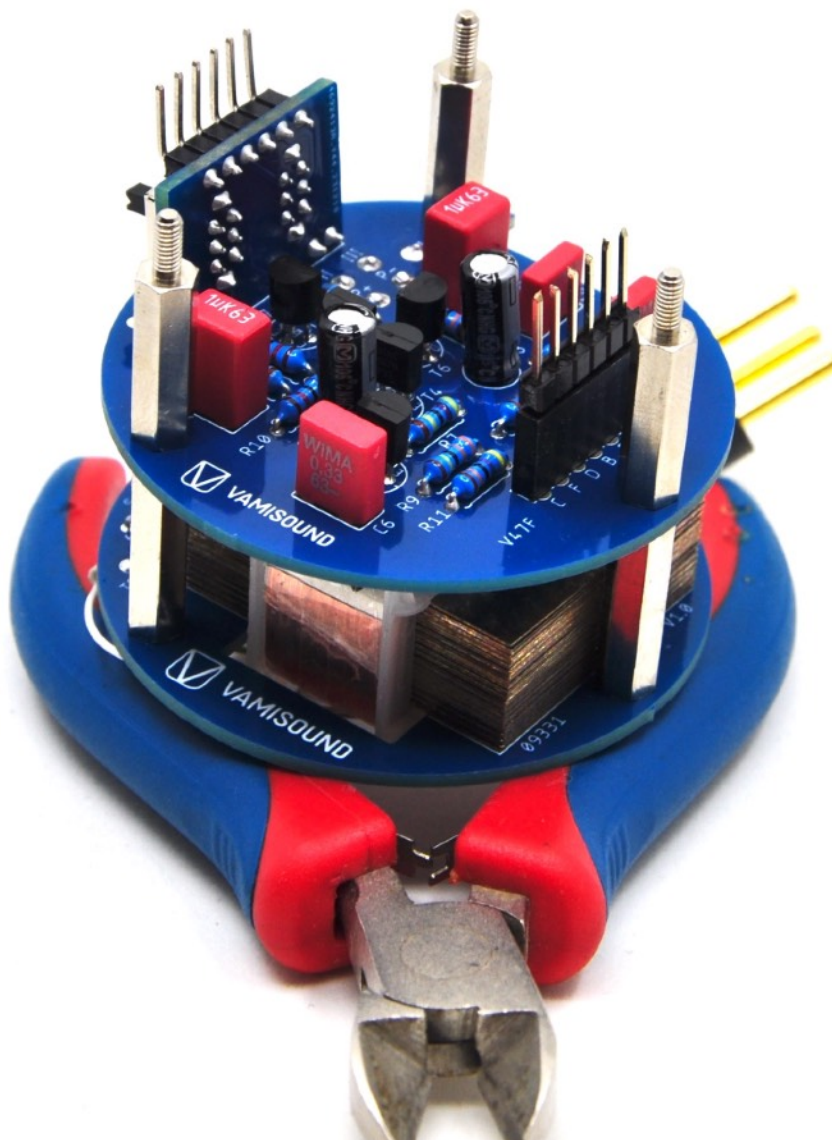

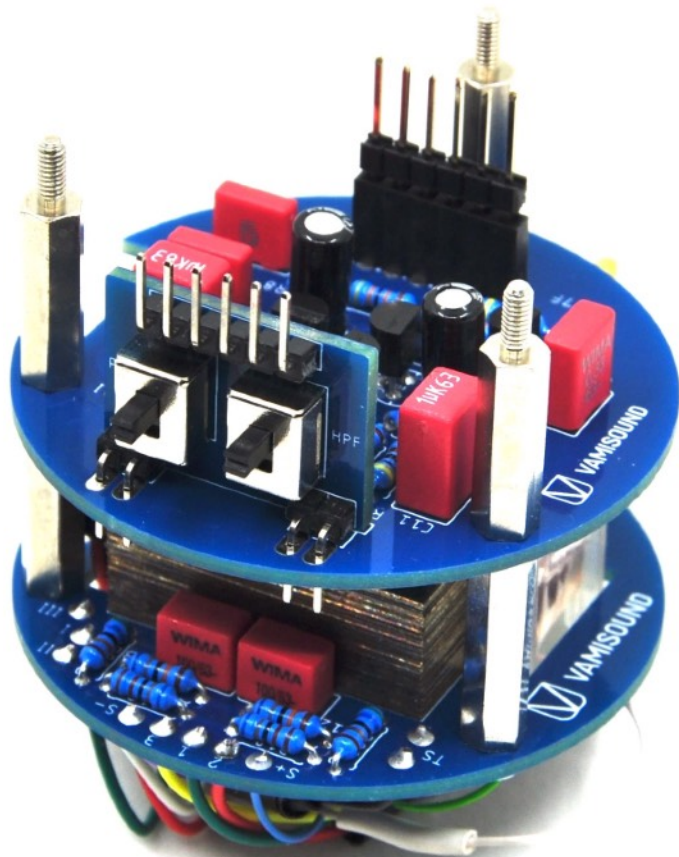

Mount the HiZ pcb on the three spacer posts and also on the pins sticking out of the switch board and the six pin connector.

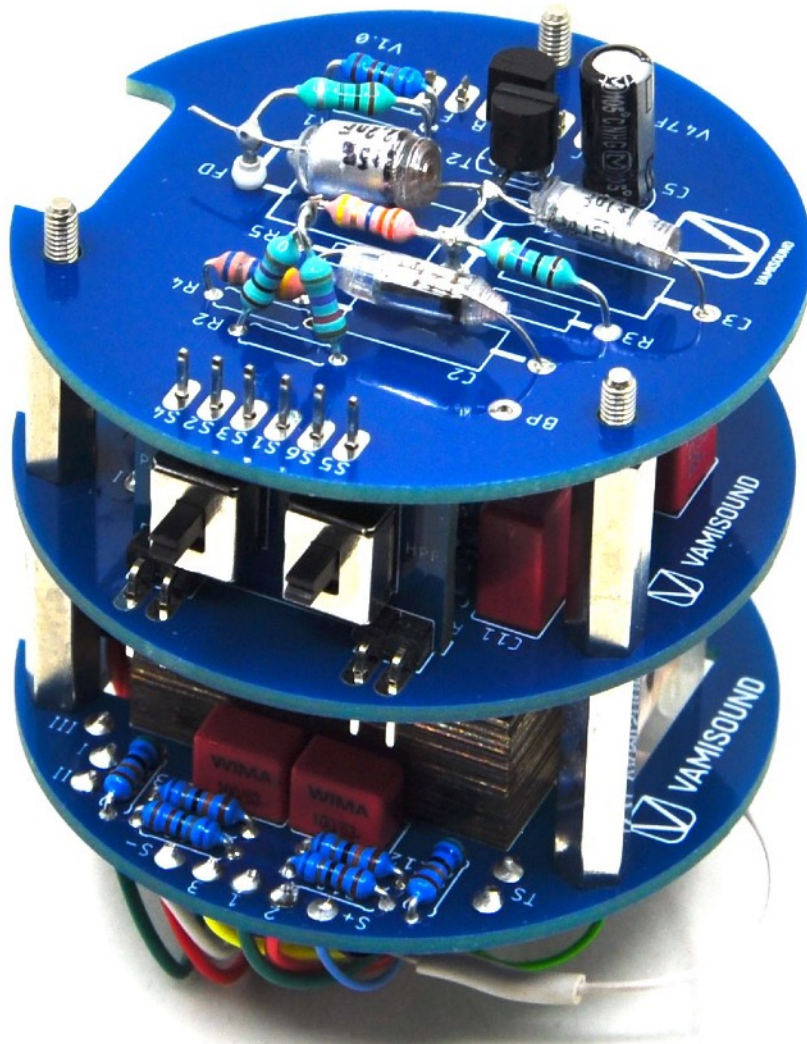

Make sure everything fits together nicely and solder everything.

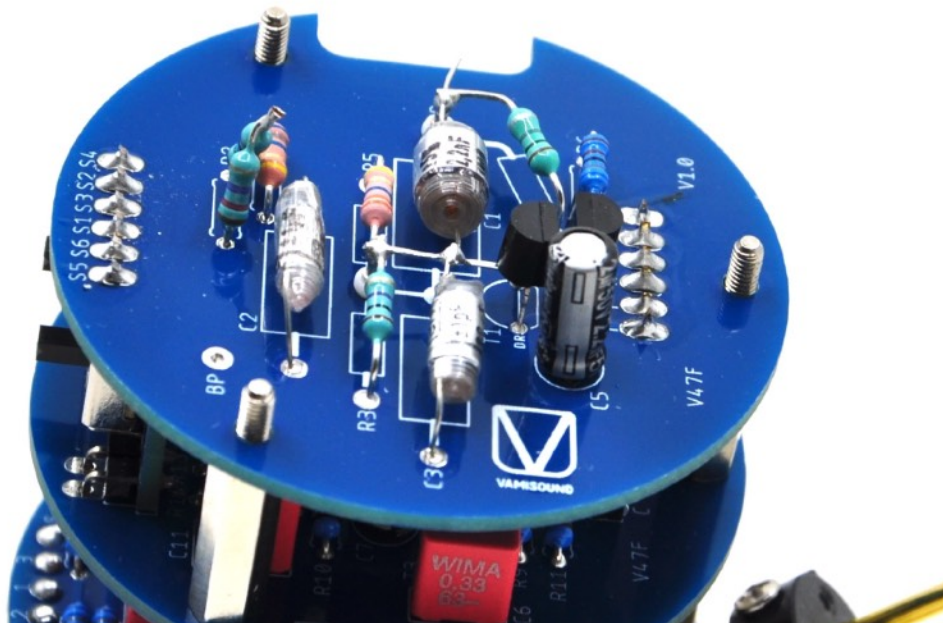

Install the K47 style capsule on the round metal plate. It is always a good idea to cover the capsule, for example with a bag, to prevent it from getting dirty.

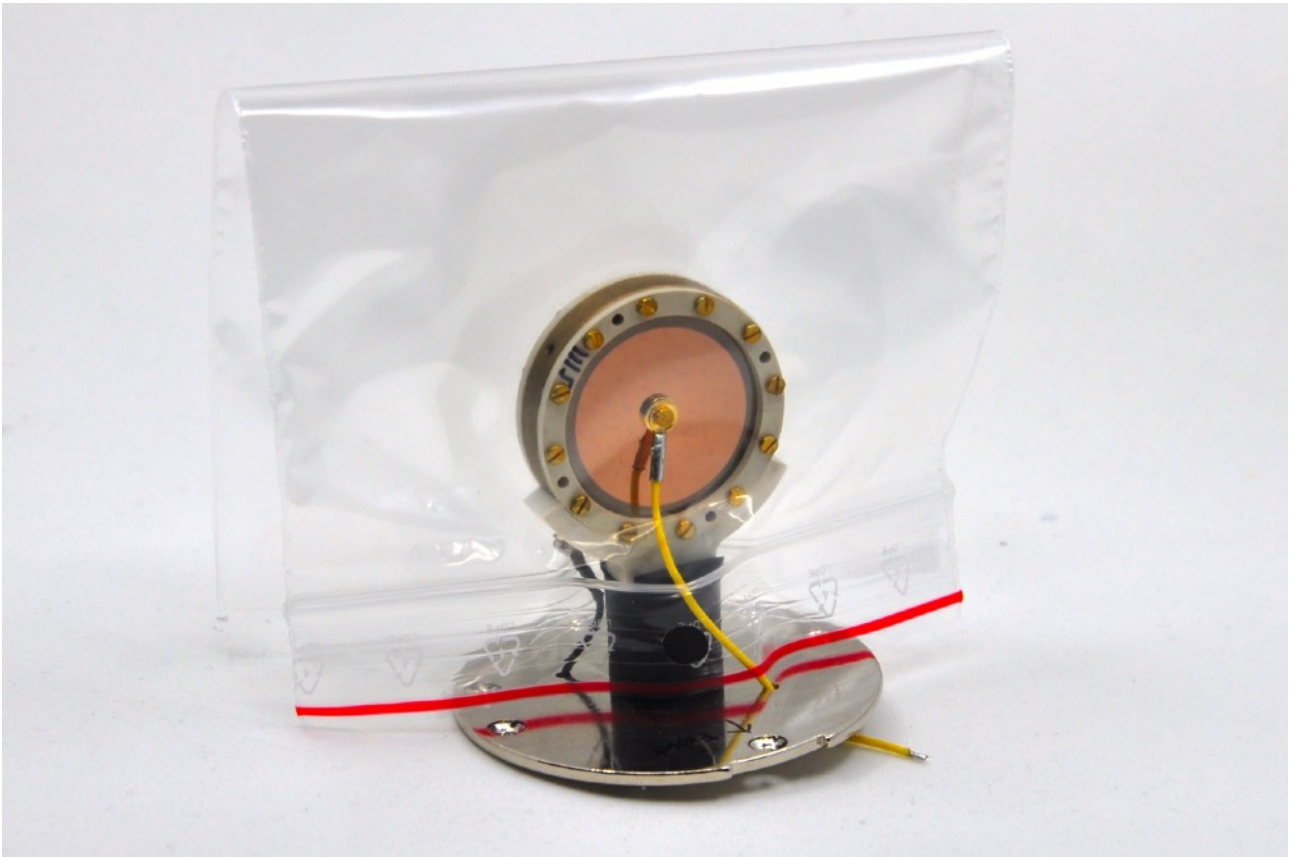

Mark where the front side of the metal plate and front side of the capsule diaphragm is.

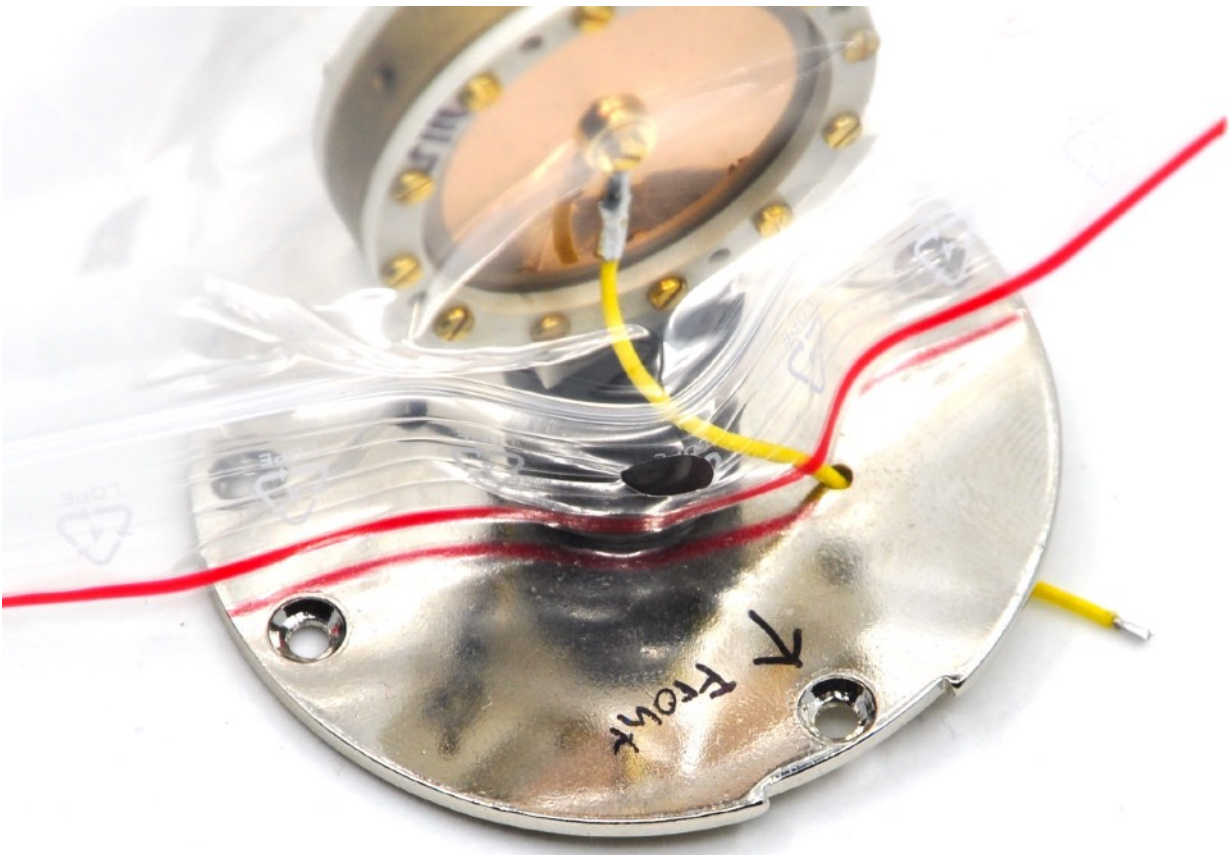

Install the three brass extensions with holes so that you can later bolt the entire assembly to the microphone body. Their threaded holes should point outwards.

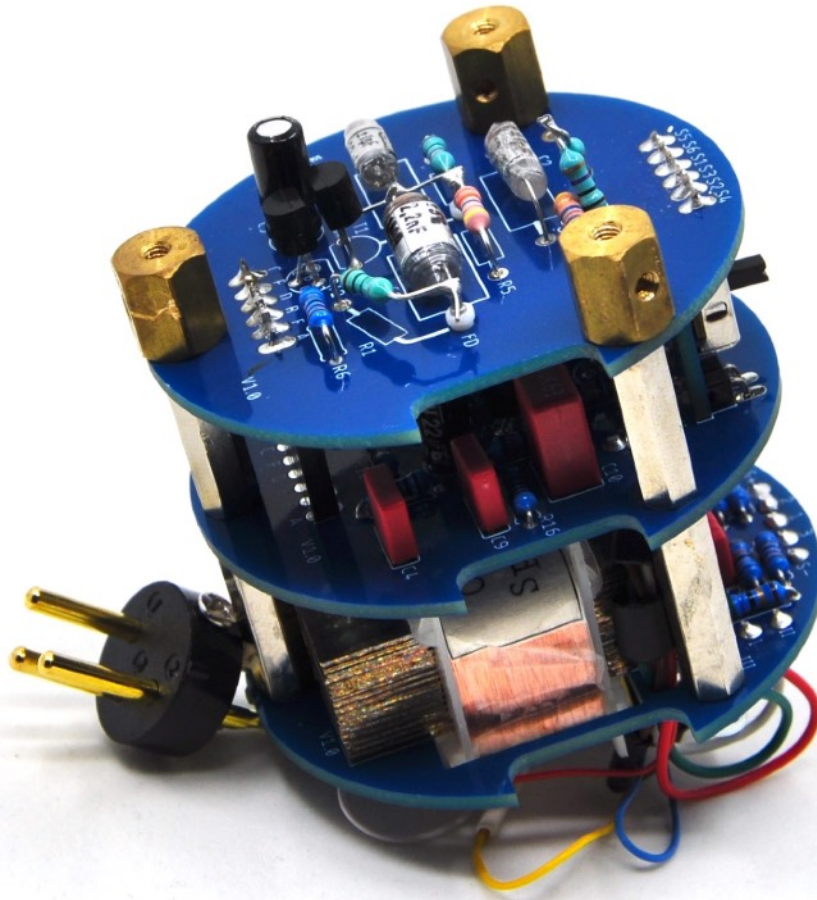

Insert the assembled plates into the microphone body. Before doing so, unscrew the bottom metal plate from the body.

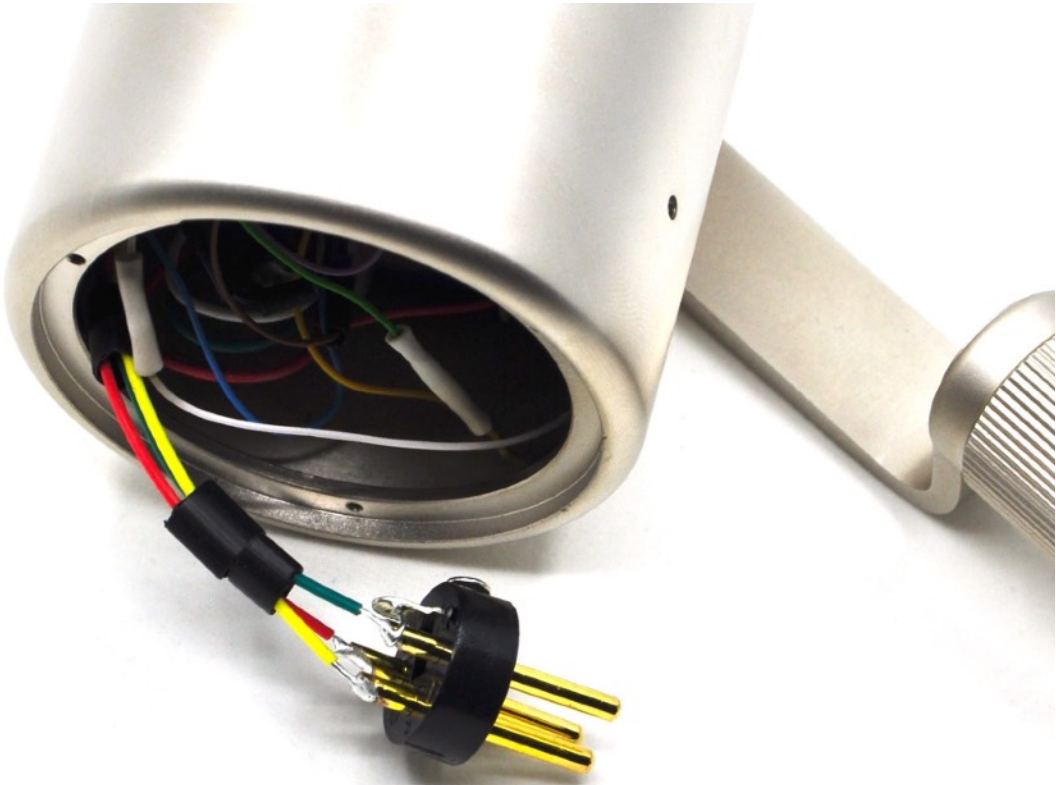
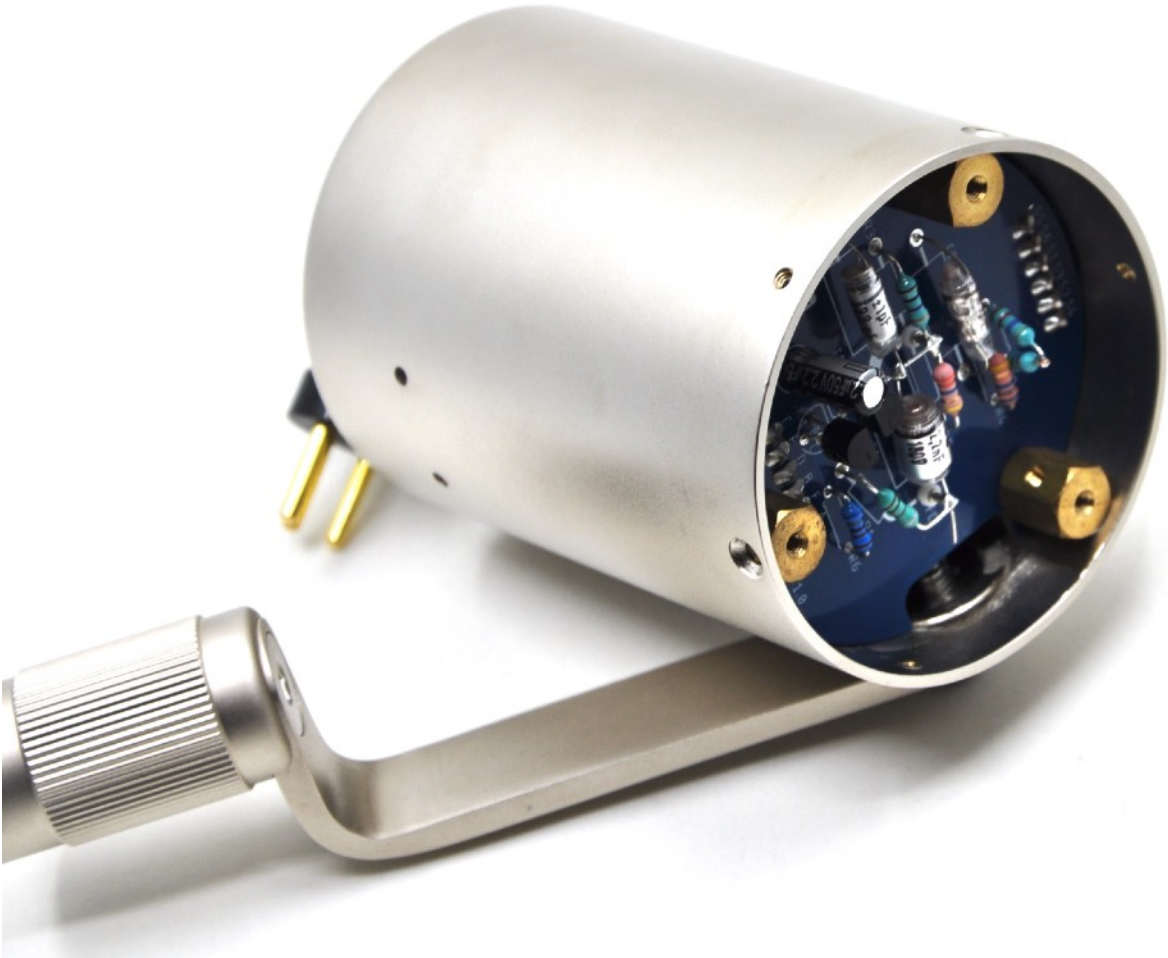

Insert the XLR insert into place and screw it in. Then screw the entire bottom metal plate to the microphone body.

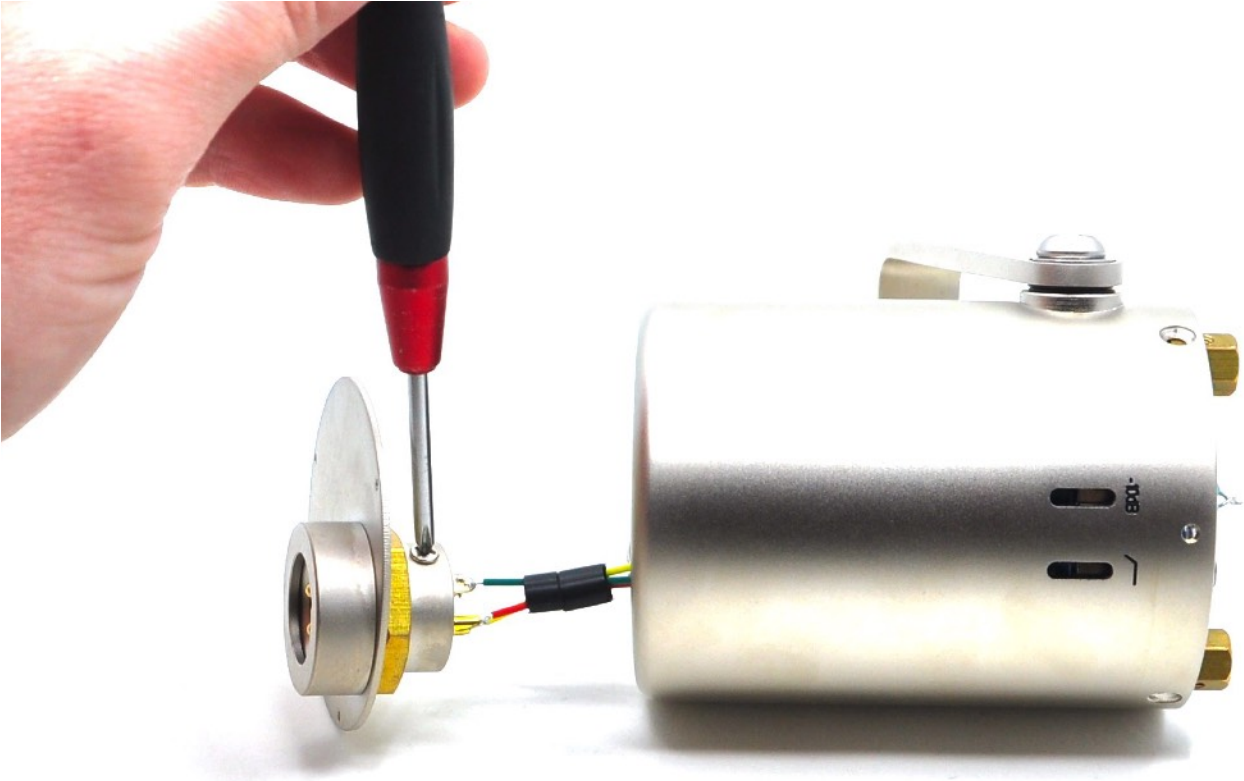

Screw the whole set of plates to the microphone body tube with three screws.

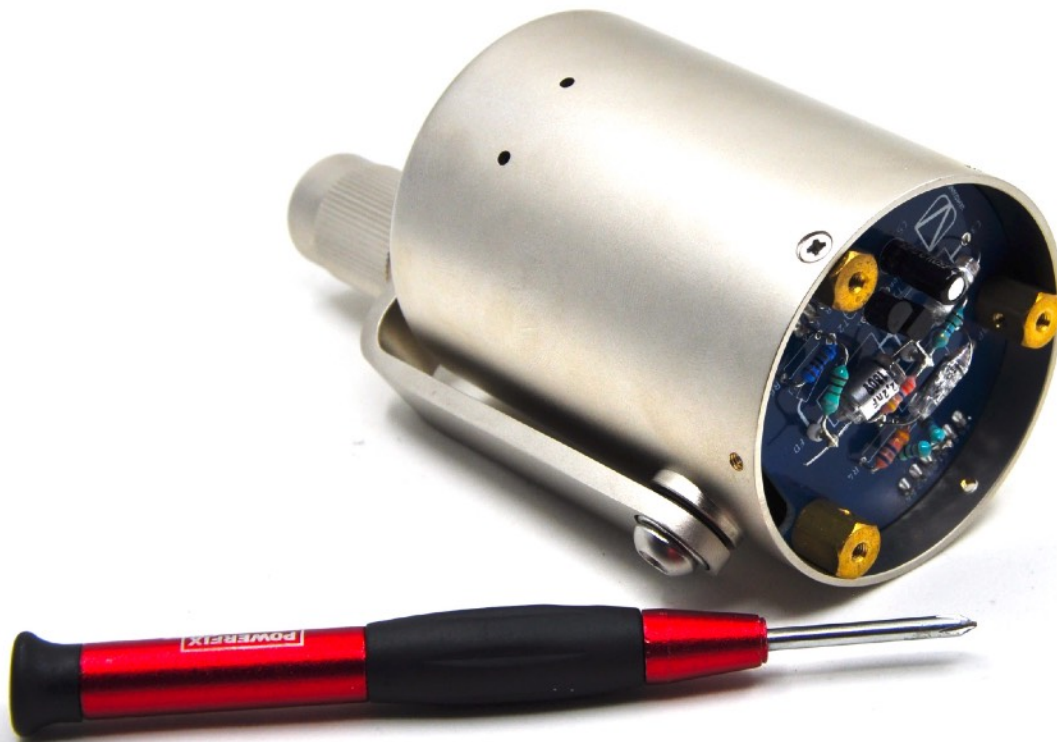

Now comes an important step. Make very sure that the components from the HiZ board will not touch anything above them and thus create a short circuit anywhere. If a component sticks out enough, bend it so that no contact can be made.

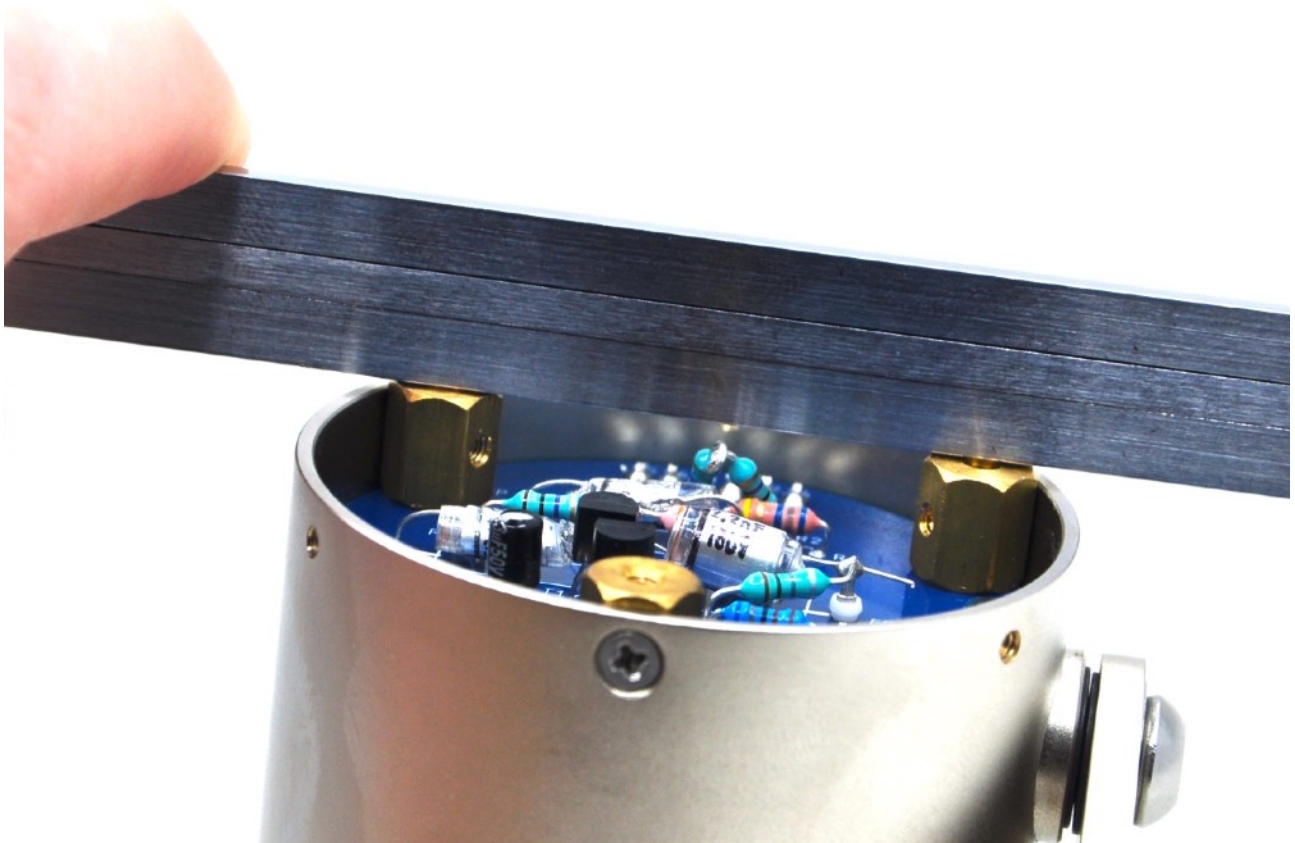

All components on the HiZ pcb must be lower than the height of the three brass mounting hexagonal stands.

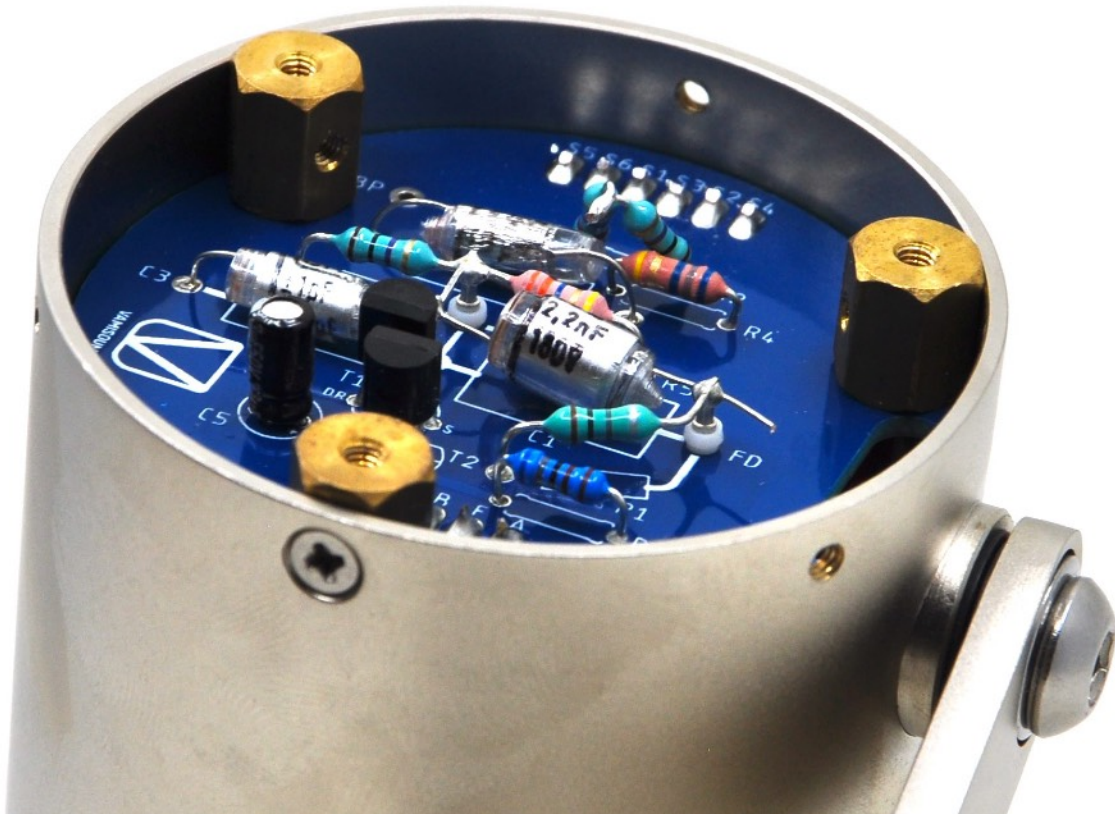

Carefully connect the two wires from the capsule to the HiZ board. The cable from the front diaphragm goes to the "FD" teflon pin on the HiZ board. Backplate wire from the capsule to the "BCKP" pad on the HiZ board.

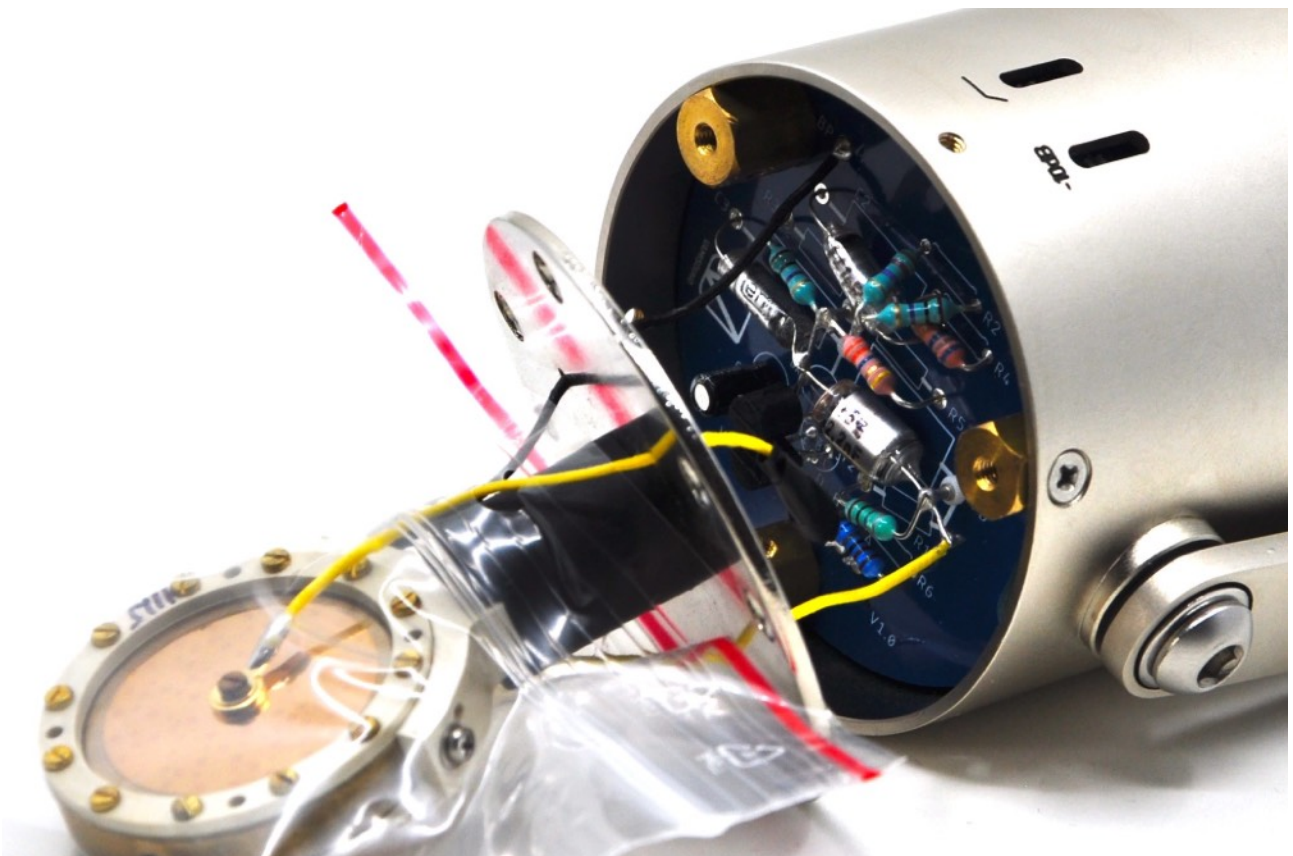

So the capsule is connected to the circuit. The cable from the rear diaphragm doesn't connect anywhere. Just insulate the end of it to prevent unwanted short circuits, e.g. to the body chassis.

Screw the entire capsule plate to the microphone chassis.



Remove the packaging from the capsule. Screw the headbasket on using the three screws.

Congratulations!!!! Your new microphone is now ready!





WIRING INFO

- 1) Capsule wiring: Front membrane cable to teflon pin marked as „FD“ from the top side of HiZ pcb. Cable from capsule backplate to „BCKP“ pad from the top side on the HiZ pcb.
- 2) Its always great idea to check phase of DIY microphone against commercial microphone. In case it was reversed, just swap the two cables on the XLR insert.
- 3) Transformer wiring: Check the transformer manual. Also, there is a detailed photo description of what to connect where in this manual.

WIRING SCHEME

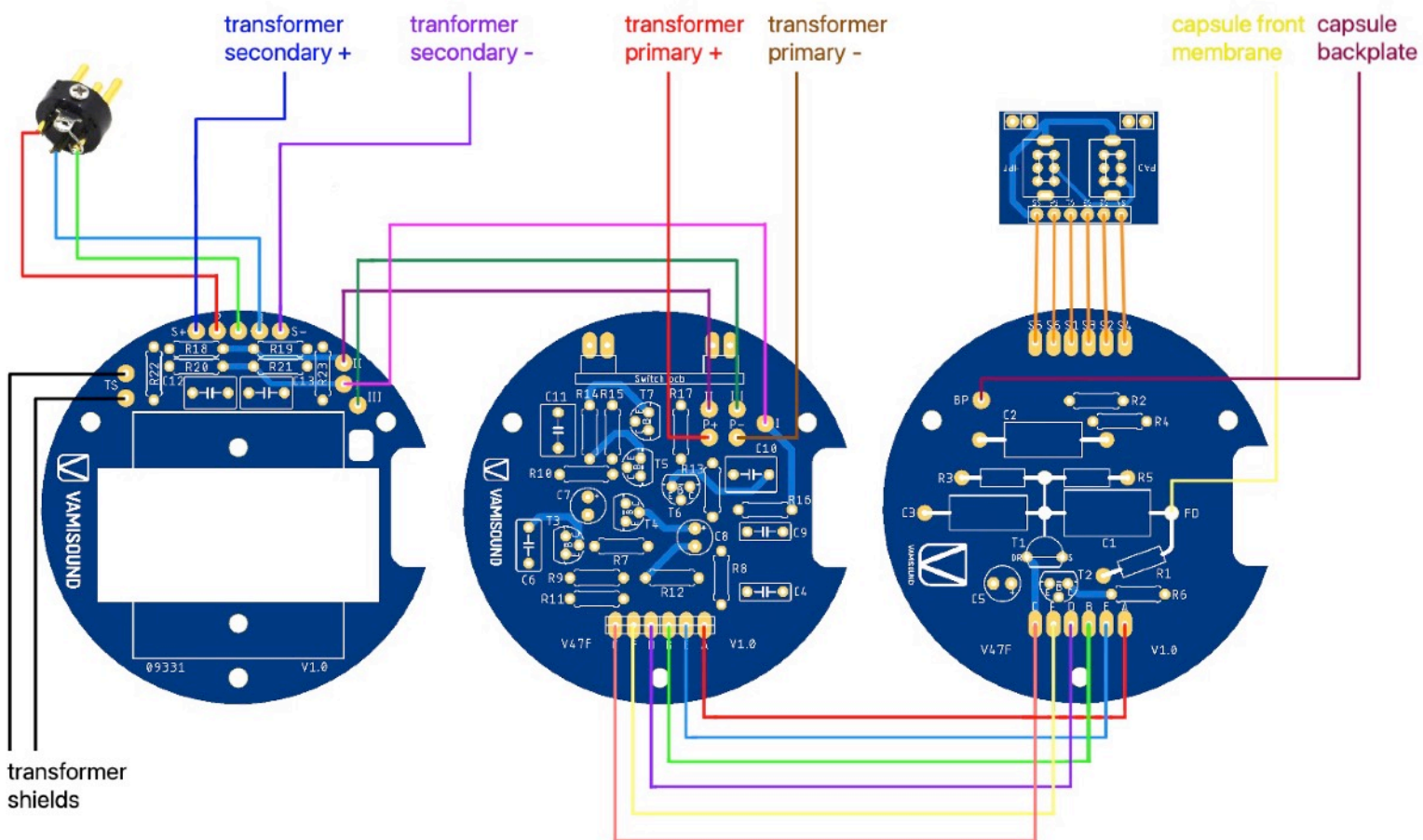

ADDITIONAL INFO

Take you time when soldering the XLR insert. You don't want to burn the plastic of the XLR insert. Take a break while soldering the individual wires.

When soldering polystyrene capacitors, be as fast as possible and do not overheat them. They could be easily damaged. Also, you can't clean them with isopropyl alcohol!!!!

BILL OF MATERIAL

Part	Value	Tol.	Min. V olt.	Dimmensions	link 1	link 2	notes
Resistors							
R1	1G	10 %		6.3x2.4mm	mouser link		
R2a	100M	5 %		6.3x2.4mm	mouser link		R2 = R2a + R2b
R2b	120M	5 %		6.3x2.4mm	mouser link		220M = 120M + 100M
R3	100M	5 %		6.3x2.4mm	mouser link		
R4	68M	5 %		6.3x2.4mm	mouser link		
R5	33M	5 %		6.3x2.4mm	mouser link		
R6	6K8	1 %		6.3x2.4mm	mouser link		
R7	4M7	1 %		6.3x2.4mm	mouser link		
R8	10M	1 %		6.3x2.4mm	mouser link		
R9	3M3	1 %		6.3x2.4mm	mouser link		
R10	47K	1 %		6.3x2.4mm	mouser link		
R11	470K	1 %		6.3x2.4mm	mouser link		
R12	430K	1 %		6.3x2.4mm	mouser link		
R13	470K	1 %		6.3x2.4mm	mouser link		
R14	4K7	1 %		6.3x2.4mm	mouser link		
R15	47K	1 %		6.3x2.4mm	mouser link		
R16	10M	1 %		6.3x2.4mm	mouser link		
R17	100K	1 %		6.3x2.4mm	mouser link		
R18	6K8	1 %		6.3x2.4mm	mouser link		matched to R19
R19	6K8	1 %		6.3x2.4mm	mouser link		matched to R18
R20	680K	1 %		6.3x2.4mm	mouser link		matched to R21
R21	680K	1 %		6.3x2.4mm	mouser link		matched to R20
R22	56R	1 %		6.3x2.4mm	mouser link		matched to R23
R23	56R	1 %		6.3x2.4mm	mouser link		matched to R22

Part	Value	Tol.	Min. V olt.	Dimmensions	link	type	notes
Capacitors							
C1	2200pF		50V			styroflex	included in set

Part	Value	Tol.	Min. V olt.	Dimmensions	link	type	notes
C2	18pF		50V			styroflex	included in set
C3	33pF		50V			styroflex	included in set
C4	0.1uF		50V		mouser link	film	
C5	2.2uF		50V		mouser link	electrolytic	7mm height max.
C6	0.33uF		50V		mouser link	film	
C7	4.7uF		6.3V		mouser link	electrolytic	
C8	22uF		3V		mouser link	electrolytic	
C9	0.1uF		50V		mouser link	film	
C10	1uF		50V		mouser link	film	
C11	1uF		50V		mouser link	film	
C12	100pF		50V		mouser link	film	
C13	100pF		50V		mouser link	film	

Part	Value	Tol.	Min. V olt.	Dimmensions	link	type	notes
Tranzistors							
T1	2N3819				mouser link		
T2	BC557B				mouser link		
T3	BC547B				mouser link		
T4	BC547B				mouser link		
T5	BC557B				mouser link		
T6	BC547B				mouser link		
T7	BC547B				mouser link		
Other							
Capsule	K47 style						
Caps. mount	depends on capsule						
Teflon pin	2x				mouser link		included in set
Switches	2x						included in set
Transformer	09331 transformer from Moby				https://www.mobytransformers.com/09331		

Part	Value	Tol.	Min. V olt.	Dimmensions	link	type	notes
Mic body	<p>U47fet style body from Aliexpress or Alibaba with three hexagonal posts for mounting. The same as clearly shown in these building instructions.</p> <p>Please note that AliExpress and Alibaba also offer a slightly different version of these bodies. These have a different internal layout, varying distances between switch holes, and a different method for mounting the board; however, they appear almost identical from the outside. If you're unsure which body to choose, please contact us—we'll be happy to help you decide.</p>						
XLR insert	3 pin XLR insert for mounting inside the microphone body						
M2.5 stand	17mm	3x					
M2.5 stand	20mm	3x					
6 pin female		1x					included in set
6 pin male		1x					included in set
90 gr. pins		3x					included in set
pcb		4x					included in set